

ZV427MG9

DIGITAL VIDEO DISC RECORDER WITH VIDEO CASSETTE RECORDER



THANK YOU FOR CHOOSING MAGNAVOX.

NEED HELP FAST?

READ YOUR QUICK GUIDE AND/OR OWNER'S MANUAL FIRST FOR QUICK TIPS THAT MAKE USING YOUR MAGNAVOX PRODUCT MORE ENJOYABLE.

IF YOU HAVE READ YOUR INSTRUCTIONS AND STILL NEED ASSISTANCE,
YOU MAY ACCESS OUR ONLINE HELP AT [HTTP://WWW.FUNAI-CORP.COM](http://www.funai-corp.com)
OR CALL **1-800-605-8610** WHILE WITH YOUR PRODUCT.

INSTRUCCIONES EN ESPAÑOL INCLUIDAS.



Quick Guide

DIGITAL VIDEO DISC RECORDER WITH VIDEO CASSETTE RECORDER ZV427MG9

Playable Discs

This unit is compatible to play back the following discs / files.

Playable discs	Logos	Playable discs	Logos
DVD-video		CD-DA (audio CD)	
DVD+RW		video CD	
DVD+R		CD-RW	
DVD-RW (Finalized video mode discs only)		CD-R	
DVD-R (Finalized video mode discs only)		Playable files	Media
		CD-DA	CD-RW/-R
		MP3	

is a trademark of DVD Format/Logo Licensing Corporation.

Region Codes

The number inside the globe refers to region of the world.
This unit can playback DVD that are labeled for ALL regions or for Region 1.



Recordable Discs

This unit can record to DVD+RW, DVD+R, DVD-RW and DVD-R. DVD+R/DVD-R can only be recorded to once. DVD+RW/DVD-RW can be recorded to and erased many times.
DVD-RW/-R will be recorded in the DVD+VR mode automatically in this unit.

• Following discs are recommended for good recording quality and are proven to be compatible with this unit. However, depending on the media condition, the unit may not read the disc properly.

Verbatim	DVD+R 8x, DVD+RW 4x, DVD-R 8x, DVD-RW 2x
JVC	DVD-RW 4x
Maxell	DVD+R 4x/8x/16x, DVD-R 8x/16x
SONY	DVD+R 4x/8x/16x, DVD+RW 4x
TDK	DVD+R 4x/8x/16x

Performance of any other discs are not guaranteed.

• You can playback DVD+RW on most DVD players without finalizing. However, if you have added or deleted chapters, or made chapters hidden, you must perform "Make Edits Compatible" before being able to see those effects on other units. (Refer to page 69 in the owner's manual.) To playback discs other than DVD+RW on other DVD players, you will need to finalize.

Logo	Attributes
	8cm/12cm, single-sided, single layer disc
	Approx. max. recording time (SLP mode):
	360 minutes (4.7GB) (for 12cm)
	108 minutes (1.4GB) (for 8cm)

Unrecordable Discs

- DVD-RW recorded in the mode other than +VR is not recordable on this unit unless you erase all contents in the disc. (Refer to page 68 in the owner's manual.)
- DVD-R recorded in the mode other than +VR is not recordable on this unit.

1

Connections

Connection to an External Tuner

- 1) Disconnect the power cords of the devices from the AC outlet.
- 2) Make the connection as illustrated below.
e.g.)

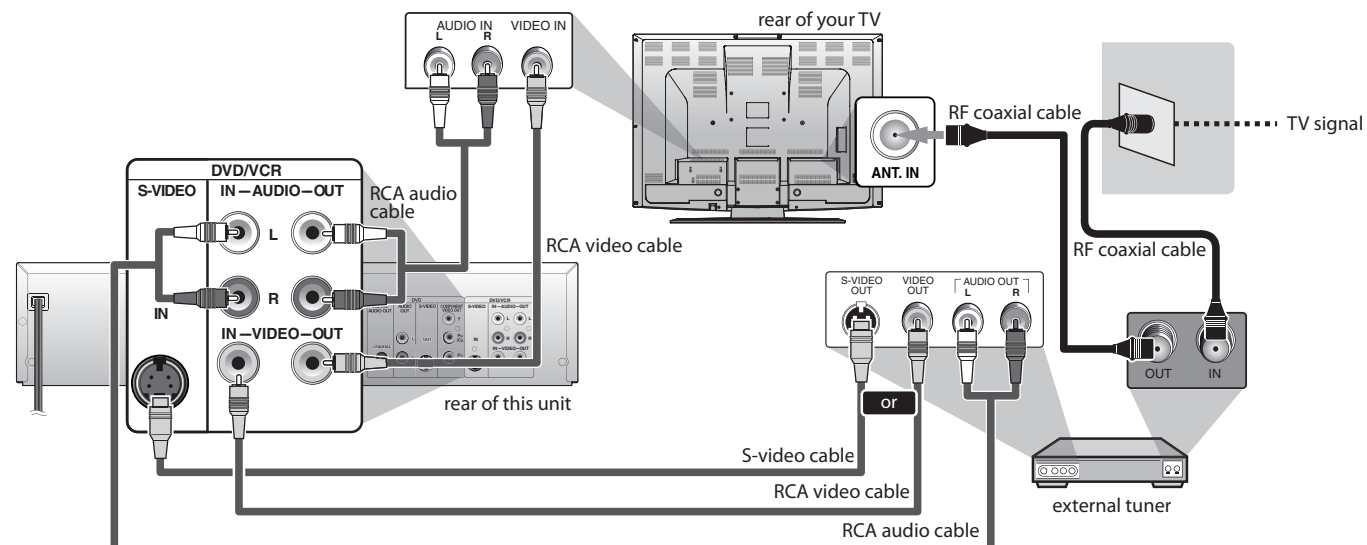

- 3) Plug in the power cords of the devices to the AC outlet.

How to Select External Input Channel on Your TV

After you have completed the connections, switch the input selector on your TV to an appropriate external input channel. Press a button on the TV's original remote control that selects an external input channel until the DVD recorder's opening picture appears. Check your TV owner's manual for details.

Settings for the Video Input

You must let the unit know which video input jack you are using before making a recording.

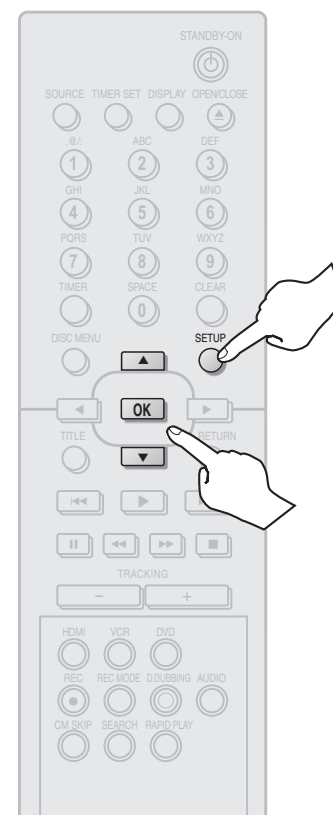

Press [SETUP] and use [▲ / ▼] to select "General Setting", then press [OK].

Use [▲ / ▼] to select "Video", then press [OK].

Use [▲ / ▼] to select "Video Input", then press [OK].

Use [▲ / ▼] to select desired external input position, then press [OK].

Use [▲ / ▼] to select the input jack type to connect, then press [OK].

Press [SETUP] to exit.

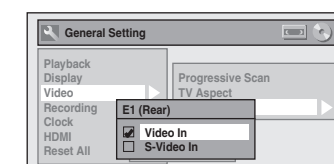
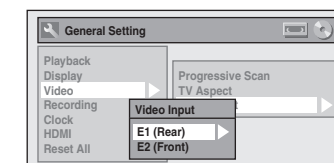

2

Initial Setting

You need to follow these steps when you turn on this unit for the first time.

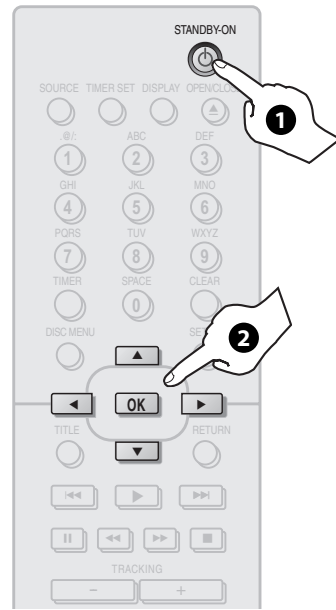

Press [STANDBY-ON].

Turn on the TV. Select the input to which the unit is connected.

Use [▲ / ▼] to select your desired language, then press [OK] to set language.

Press [OK] to activate "Clock Setting".

Use [◀ / ▶] to select an item to set, and use [▲ / ▼] to select the contents to suit your preference, then press [OK].

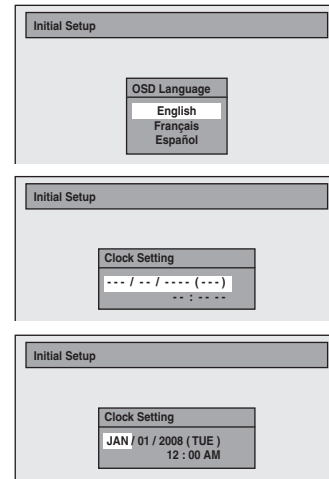

3

DVD Recording

3-1 Basic Recording

1 Press [DVD].

2 Press [OPEN/CLOSE ▲] to open the disc tray and insert your disc with its label facing up.

* Make sure the disc is compatible with this unit. (Refer to page 24 in the owner's manual for the list of compatible discs.)

3 Press [REC MODE] to select a recording mode.

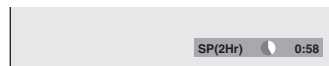

Recording mode	Recording time		Video/sound quality
	8cm Disc	12cm Disc	
HQ (1Hr)	18 min	60 min	Good ↑ ↓ Poor
SP (2Hr)	36 min	120 min	
SPP (2.5Hr)	45 min	150 min	
LP (3Hr)	54 min	180 min	
EP (4Hr)	72 min	240 min	
SLP (6Hr)	108 min	360 min	

4 Press [SOURCE] to select the appropriate external input position (E1/E2) to which your external tuner is connected. Then select the desired channel to record on the external tuner.

5 Press [REC ●] to start recording.

6 Press [STOP ■] to stop recording.

To set one-touch timer recording (OTR)...

This is a simple way to set the recording time in blocks of 30 minutes. Press [REC ●] repeatedly until the desired recording time (30 minutes to 6 hours) appears on the TV screen. One-touch timer recording will start.

• To cancel one-touch timer recording within the specified time, press [STOP ■].

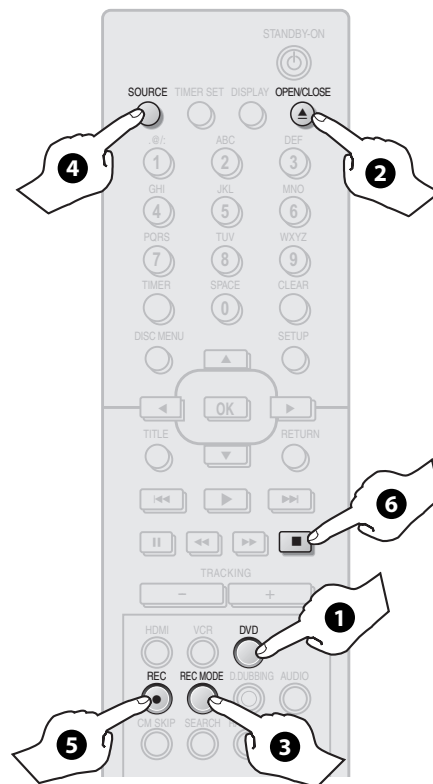
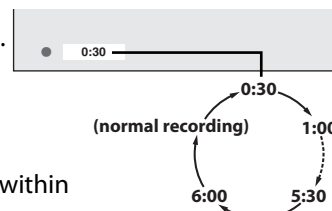

3-2 Timer Recording

You can program the unit to record up to 12 programs within one month in advance. Daily or weekly program recordings are also available.

Before recording, make sure

- Connect the external tuner to either E1 or E2 and set it to output audio/video signals when it comes to the time you want to start recording.
- Do not change the external tuner's channel while you are recording. You cannot watch one channel and record another at the same time.
- Set the clock before setting a timer programming.
- Insert a recordable disc with enough recordable space or a cassette tape with an erase-protection tab.

1 Press [TIMER].

2 Use [▲ / ▼] to select "New Program", then press [OK].

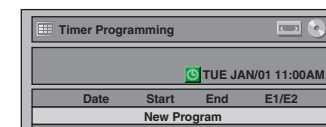

3 Set a timer programming.

4 Press [OK].

5 Press [TIMER SET] to set a timer programming.

will appear on the front panel display.

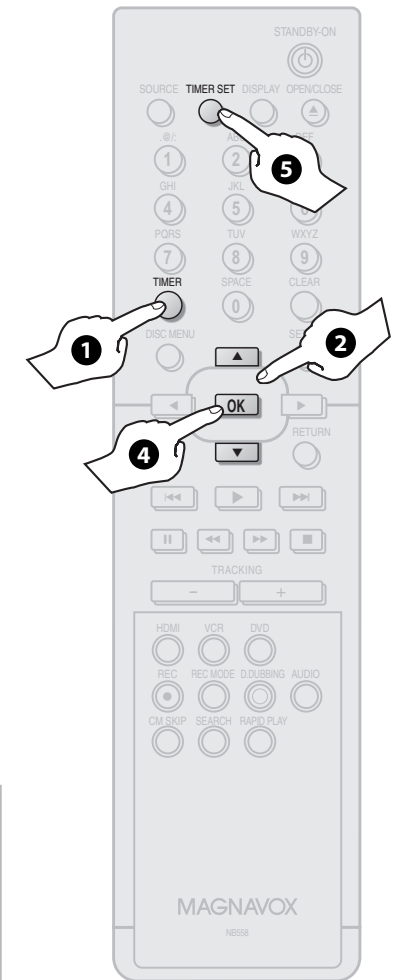

Set the date.

Set starting and ending time.

Select the appropriate external input position (E1/E2) to which your external tuner is connected.

Select a recording media ("DVD" or "VCR").

Select a recording mode.

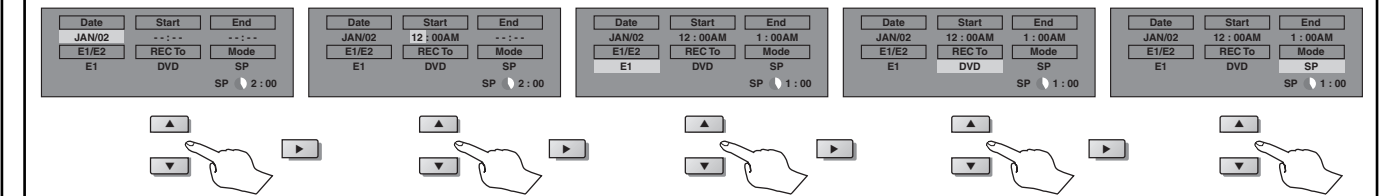

4

Playback

1 Open the disc tray.

2 Insert a disc.

3 Start playing back.

4 Stop playing back.

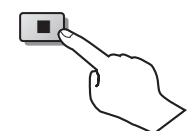
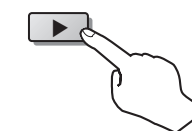
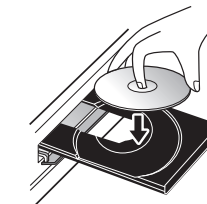

PRECAUTIONS

WARNING: TO REDUCE THE RISK OF FIRE OR ELECTRIC SHOCK, DO NOT EXPOSE THIS APPLIANCE TO RAIN OR MOISTURE.



CAUTION
RISK OF ELECTRIC SHOCK
DO NOT OPEN



CAUTION:

TO REDUCE THE RISK OF ELECTRIC SHOCK, DO NOT REMOVE COVER (OR BACK). NO USER SERVICEABLE PARTS INSIDE. REFER SERVICING TO QUALIFIED SERVICE PERSONNEL.



The lightning flash with arrowhead symbol, within an equilateral triangle, is intended to alert the user to the presence of uninsulated "dangerous voltage" within the product's enclosure that may be of sufficient magnitude to constitute a risk of electric shock to persons.



The exclamation point within an equilateral triangle is intended to alert the user to the presence of important operating and maintenance (servicing) instructions in the literature accompanying the appliance.

The caution marking is located on the rear of the cabinet.

Laser Safety

This unit employs a laser. Only a qualified service person should remove the cover or attempt to service this device, due to possible eye injury.

CAUTION: USE OF CONTROLS OR ADJUSTMENTS OR PERFORMANCE OF PROCEDURES OTHER THAN THOSE SPECIFIED HEREIN MAY RESULT IN HAZARDOUS RADIATION EXPOSURE.

CAUTION: VISIBLE AND INVISIBLE LASER RADIATION WHEN OPEN AND INTERLOCK DEFEATED. DO NOT STARE INTO BEAM.

LOCATION: INSIDE, NEAR THE DECK MECHANISM.

FCC WARNING- This equipment may generate or use radio frequency energy. Changes or modifications to this equipment may cause harmful interference unless the modifications are expressly approved in the manual. The user could lose the authority to operate this equipment if an unauthorized change or modification is made.

RADIO-TV INTERFERENCE

This equipment has been tested and found to comply with the limits for a Class B digital device, pursuant to Part 15 of the FCC Rules. These limits are designed to provide reasonable protection against harmful interference in a residential installation. This equipment generates, uses, and can radiate radio frequency energy and, if not installed and used in accordance with the instructions, may cause harmful interference to radio communications. However, there is no guarantee that interference will not occur in a particular installation. If this equipment does cause harmful interference to radio or television reception, which can be determined by turning the equipment off and on, the user is encouraged to try to correct the interference by one or more of the following measures:

- 1) Reorient or relocate the receiving antenna.
- 2) Increase the separation between the equipment and receiver.
- 3) Connect the equipment into an outlet on a circuit different from that to which the receiver is connected.
- 4) Consult the dealer or an experienced radio/TV technician for help.

This Class B digital apparatus complies with Canadian ICES-003.

Cet appareil numérique de la classe B est conforme à la norme NMB-003 du Canada.

CAUTION: TO PREVENT ELECTRIC SHOCK, MATCH WIDE BLADE OF PLUG TO WIDE SLOT, FULLY INSERT.

ATTENTION: POUR ÉVITER LES CHOCS ÉLECTRIQUES, INTRODUIRE LA LAME LA PLUS LARGE DE LA FICHE DANS LA BORNE CORRESPONDANTE DE LA PRISE ET POUSSER JUSQU'AU FOND.

A NOTE ABOUT RECYCLING

This product's packaging materials are recyclable and can be reused. Please dispose of any materials in accordance with your local recycling regulations.

Batteries should never be thrown away or incinerated but disposed of in accordance with your local regulations concerning chemical wastes.

Make your contribution to the environment!!!

- Used up batteries do not belong in the dust bin.
- You can dispose of them at a collection point for used up batteries or special waste. Contact your council for details.



For Customer Use:

Read carefully the information located at the back of this unit and enter below the Model No. and Serial No. Retain this information for future reference.

Model No. _____

Serial No. _____

Important Safeguards

1. Read Instructions - All the safety and operating instructions should be read before the appliance is operated.
2. Retain Instructions- The safety and operating instructions should be retained for future reference.
3. Heed Warnings - All warnings on the appliance and in the operating instructions should be adhered to.
4. Follow Instructions - All operating and use instructions should be followed.
5. Cleaning - Unplug this product from the wall outlet before cleaning. Do not use liquid cleaners or aerosol cleaners. Use a damp cloth for cleaning.
EXCEPTION: A product that is meant for uninterrupted service and, that for some specific reason, such as the possibility of the loss of an authorization code for a CATV converter, is not intended to be unplugged by the user for cleaning or any other purpose, may exclude the reference to unplugging the appliance in the cleaning description otherwise required in item 5.
6. Attachments - Do not use attachments not recommended by the product manufacturer as they may cause hazards.
7. Water and Moisture- Do not use this product near water, for example, near a bath tub, wash bowl, kitchen sink, or laundry tub, in a wet basement, or near a swimming pool, and the like.
8. Accessories - Do not place this product on an unstable cart, stand, tripod, bracket, or table. The product may fall, causing serious injury to a child or adult, and serious damage to the appliance. Use only with a cart, stand, tripod, bracket, or table recommended by the manufacturer, or sold with the product. Any mounting of the appliance should follow the manufacturer's instructions and should use a mounting accessory recommended by the manufacturer. An appliance and cart combination should be moved with care. Quick stops, excessive force, and uneven surfaces may cause the appliance and cart combination to overturn.
9. Ventilation - Slots and openings in the cabinet are provided for ventilation and to ensure reliable operation of the product and to protect it from overheating, and these openings must not be blocked or covered. The openings should never be blocked by placing the product on a bed, sofa, rug, or other similar surface. This product should not be placed in a built-in installation such as a bookcase or rack unless proper ventilation is provided or the manufacturer's instructions have been adhered to.
10. Power Sources - This product should be operated only from the type of power source indicated on the marking label. If you are not sure of the type of power supply to your home, consult your appliance dealer or local power company. For products intended to operate from battery power, or other sources, refer to the operating instructions.
11. Grounding or Polarization - This product is equipped with a polarized alternating-current line plug (a plug having one blade wider than the other). This plug will fit into the power outlet only one way. This is a safety feature. If you are unable to insert the plug fully into the outlet, try reversing the plug. If the plug should still fail to fit, contact your electrician to replace your obsolete outlet. Do not defeat the safety purpose of the polarized plug.
12. Power Cord Protection - Power supply cords should be routed so that they are not likely to be walked on or pinched by items placed upon or against them, paying particular attention to cords at plugs, convenience receptacles, and the point where they exit from the appliance.
13. Lightning - For added protection for this product during a lightning storm, or when it is left unattended and unused for long periods of time, unplug it from the wall outlet. This will prevent damage to the product due to lightning and power-line surges.
14. Power Lines - An outside antenna system should not be located in the vicinity of overhead power lines or other electric light or power circuits, or where it can fall into such power lines or circuits. When installing an outside antenna system, extreme care should be taken to keep from touching such power lines or circuits as contact with them might be fatal.
15. Overloading - Do not overload wall outlets and extension cords as this can result in a risk of fire or electric shock.
16. Object and Liquid Entry - Never push objects of any kind into this product through any openings as they may touch dangerous voltage points or short-out parts that could result in a fire or electric shock. Never spill liquid of any kind on the product.
17. Servicing - Do not attempt to service this product yourself as opening or removing covers may expose you to dangerous voltage or other hazards. Refer all servicing to qualified service personnel.
18. Damage Requiring Service - Unplug this product from the wall outlet and refer servicing to qualified service personnel under the following conditions:
 - a. When the power-supply cord or plug is damaged.
 - b. If liquid has been spilled, or objects have fallen into the product.
 - c. If the product has been exposed to rain or water.
 - d. If the product does not operate normally by following the operating instructions. Adjust only those controls that are covered by the operating instructions as an improper adjustment of other controls may result in damage and will often require extensive work by a qualified technician to restore the product to its normal operation.
 - e. If the product has been dropped or damaged in any way.
 - f. When the product exhibits a distinct change in performance this indicates a need for service.
19. Replacement Parts - When replacement parts are required, be sure the service technician has used replacement parts specified by the manufacturer or have the same characteristics as the original part. Unauthorized substitutions may result in fire, electric shock or other hazards.
20. Safety Check - Upon completion of any service or repairs to this product, ask the service technician to perform safety checks to determine that the product is in proper operating condition.
21. Heat - This product should be situated away from heat sources such as radiators, heat registers, stoves, or other products (including amplifiers) that produce heat.

PORTABLE CART WARNING
(Symbol provided by RETAC)



Do not place the unit on the furniture that is capable of being tilted by a child and an adult leaning, pulling, standing or climbing on it. A falling unit can cause serious injury or even death.

PRECAUTIONS

Installation Location

For safety and optimum performance of this unit:

- Install the unit in a horizontal and stable position. Do not place anything directly on top of the unit. Do not place the unit directly on top of the TV.
- Shield it from direct sunlight and keep it away from devices of intense heat. Avoid dusty or humid places. Avoid places with insufficient ventilation for proper heat dissipation. Do not block the ventilation holes on the sides of the unit. Avoid locations subject to strong vibration or strong magnetic fields.

Avoid the Hazards of Electrical Shock and Fire

- Do not handle the power cord with wet hands.
- Do not pull on the power cord when disconnecting it from AC outlet. Grasp it by the plug.
- If, by accident, water is spilled on this unit, unplug the power cord immediately and take the unit to our Authorized Service Center for servicing.

Moisture Condensation Warning

Moisture condensation may occur inside the unit when it is moved from a cold place to a warm place or after heating a cold room or under conditions of high humidity. Do not use this unit at least for 2 hours until its inside gets dry.

About Copyright

Unauthorized copying, broadcasting, public performance and lending of discs are prohibited.

This product incorporates copyright protection technology that is protected by U.S. patents and other intellectual property rights. Use of this copyright protection technology must be authorized by Macrovision, and is intended for home and other limited viewing uses only unless otherwise authorized by Macrovision. Reverse engineering or disassembly is prohibited.

Notice for Progressive Scan Output

Consumers should note that not all high definition television sets are fully compatible with this product and may cause artifacts to be displayed in the picture. In case of picture problems with 525 (480) progressive scan output, it is recommended that the user switch the connection to the 'standard definition' output. If there are questions regarding your TV set compatibility with this 525p (480p) DVD player, please contact our customer service center.

Supplied Accessories

remote control (NB558UD) with batteries (AAx2)

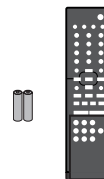

RCA audio/video cables (WPZ0102TM018/WPZ0102LTE01)

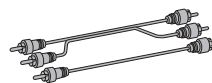

owner's manual (1VMN25333)



quick guide (1VMN25334)



PRECAUTIONS

Maintenance

Servicing

- Please refer to relevant topics on "TROUBLESHOOTING" on pages 81-84 before returning the product.
- If this unit becomes inoperative, do not try to correct the problem by yourself. There are no user-serviceable parts inside. Turn off, unplug the power plug and please call our help line mentioned on the front page to locate an Authorized Service Center.

Cleaning the cabinet

- Use a soft cloth slightly moistened with a mild detergent solution. Do not use a solution containing alcohol, spirits, ammonia or abrasive.

Cleaning discs

- When a disc becomes dirty, clean it with a cleaning cloth. Wipe the disc from the center to out. Do not wipe in a circular motion.
- Do not use solvents such as benzene, thinner, commercially available cleaners, detergent, abrasive cleaning agents or antistatic spray intended for analog records.

Cleaning the disc lens

- If this unit still does not perform properly although you refer to the relevant sections and to "TROUBLESHOOTING" in this owner's manual, the laser optical pickup unit may be dirty. Consult your dealer or an Authorized Service Center for inspection and cleaning of the laser optical pickup unit.

Disc handling

- Handle the discs so that fingerprints and dust do not adhere to the surfaces of the discs.
- Always store the disc in its protective case when it is not used.

Auto head cleaning

- Automatically cleans video heads as you insert or remove a cassette, so you can see a clear picture.
 - Playback picture may become blurred or interrupted while the TV program reception is clear. Dirt accumulated on the video heads after a long period of use, or the usage of rental or worn tapes can cause this problem. If a streaky or snowy picture appears during playback, the video heads in your unit may need to be cleaned.
1. Please visit your local Audio/Video store and purchase a good quality VHS video head cleaner.
 2. If a video head cleaner does not solve the problem, please consult your dealer or an Authorized Service Center.

Note

- Remember to read the instructions along with the video head cleaner before use.
- Clean video heads only when problems occur.

IR signal check

If the remote control does not work properly, you can test if the remote control sends out the infrared signal with AM radio or a digital camera (including built-in camera of cellular phone). It will help to define the cause of malfunction.

• With an AM radio:

Tune an AM radio to a station with no broadcasting. Press a button on remote control toward the radio. Sound will be fluttering when you press any key and the radio receives the signal. This means the remote control is working.



• With a digital camera (including built-in camera of cellular phone):

Direct a digital camera to remote control, press and hold a button on remote control. If infrared light appears through digital camera, the remote control is working.



Manufactured under license from Dolby Laboratories. Dolby and the double-D symbol are trademarks of Dolby Laboratories.

Dolby Digital Recording

"Dolby® Digital Recording enables consumers to record high-quality video with stereo sound on recordable DVD discs. The technology, when utilized instead of PCM recording, also saves recordable disc space, allowing for higher video resolution or extended recording time on each DVD. DVDs created using Dolby Digital Recording will play back on all DVD-video players."

Note: This is true when the players are compatible with actual recordable DVD discs.



HDMI, the HDMI logo and High-Definition Multimedia Interface are trademarks or registered trademarks of HDMI Licensing LLC.

© 2008 Funai Electric Co., Ltd.

All rights reserved. No part of this manual may be reproduced, copied, transmitted, disseminated, transcribed, downloaded or stored in any storage medium, in any form or for any purpose without the express prior written consent of Funai. Furthermore, any unauthorized commercial distribution of this manual or any revision hereto is strictly prohibited.

Information in this document is subject to change without notice. Funai reserves the right to change the content herein without the obligation to notify any person or organization of such changes.

FUNAI with the  design is a registered trademark of Funai Electric Co., Ltd and may not be used in any way without the express written consent of Funai. All other trademarks used herein remain the exclusive property of their respective owners. Nothing contained in this manual should be construed as granting, by implication or otherwise, any license or right to use any of the trademarks displayed herein. Misuse of any trademarks or any other content in this manual is strictly prohibited. Funai shall aggressively enforce its intellectual property rights to the fullest extent of the law.

CONTENTS

Introduction

PRECAUTIONS	2
FEATURES	7
Symbols Used in this Owner's Manual	7
FUNCTIONAL OVERVIEW	8
Front Panel	8
Rear Panel	9
Remote Control	10
Front Panel Display	12

Connections

CONNECTION TO AN EXTERNAL TUNER	13
CONNECTION TO AN EXTERNAL DEVICE	14
SETTINGS FOR THE VIDEO INPUT	15
CONNECTION TO A TV	16
CONNECTION TO A TV WITH AN HDMI™	
COMPATIBLE PORT	17
CONNECTION TO AN AUDIO SYSTEM	18

Basic Setup

THE DVD / VCR RECORDER SWITCHING	19
GUIDE TO ON-SCREEN DISPLAYS AND MENUS	20
On-Screen Display / Menu	20
Main Menu	21
INITIAL SETTING	22
SETTING THE CLOCK	23
Clock Setting	23

Recording

INFORMATION ON DVD RECORDING	24
BEFORE RECORDING	25
Make Recording Compatible	25
Setting for Auto Chapter	25
BASIC RECORDING &	
ONE-TOUCH TIMER RECORDING	26
TIMER RECORDING	28
Hints for Timer Recording	31
SATELLITE LINK	32
OVERWRITING UNNECESSARY TITLE	34
Overwriting from the Beginning of the Title	34
Overwriting in the Middle of the Title	34
Hints for Overwriting	35
EXTERNAL DEVICE RECORDING	36
Recording from an External Device	36
SETTING A DISC TO PROTECT	37
PLAYING THE DISCS IN OTHER DVD PLAYERS	38
Finalizing a Disc	38
Auto Finalizing	39
DUBBING MODE	40

Playback

INFORMATION ON PLAYBACK	42
BASIC PLAYBACK	43
Direct Playback	43
Playback from the Title List	44
Playing Back an Audio CD and a CD-RW/-R with MP3 Files	46
Using the Title / Disc Menu	47
Pause	47
SPECIAL PLAYBACK	48
Resume Playback	48
Fast Forward / Fast Reverse Playback	48
Skipping TV Commercials During Playback	48
Rapid Playback	49

Step by Step Playback	49
Slow Forward / Slow Reverse Playback	49
Zoom	50
Marker Setting	50
SEARCH	51
Title / Chapter Search	51
Track Search	51
Time Search	52
REPEAT / RANDOM / PROGRAM PLAYBACK	53
Repeat Playback	53
Random Playback	53
Program Playback	54
SPECIAL SETTING	55
Switching Subtitles	55
Switching Audio Soundtrack	55
Switching Virtual Surround System	56
Switching Camera Angles	56
Reducing Block Noise	56

Editing

INFORMATION ON DISC EDITING	57
Guide to a Title List	57
Editing Discs	57
EDITING DISCS	58
Deleting Titles	58
Putting Names on Titles	59
Setting Chapter Marks	60
Clearing Chapter Marks	61
Hiding Chapters	63
Setting Pictures for Thumbnails	64
Dividing a Title	65
Putting Name on Disc	66
Setting or Releasing Disc Protect	67
Erasing Disc	68
Making Edits Compatible	69

Function Setup

LIST OF SETTINGS	70
SETUPS	72
Playback	72
Display	75
Video	76
HDMI	77
Reset All	78

VCR Functions

VCR FUNCTIONS	79
Playback	79
Recording	79
One-touch Timer Recording (OTR)	79
Index Search	80
Time Search	80
Other Operations	80

Others

TROUBLESHOOTING	81
Frequently Asked Questions	83
LANGUAGE CODE	85
GLOSSARY	86
SPECIFICATIONS	87

Español

ESPAÑOL	88
----------------------	-----------

LIMITED WARRANTY	Back cover
-------------------------------	-------------------

FEATURES

This unit not only plays back DVD, CD and VCR but also offers features for you to record on DVD and edit them after that. The following features are offered with this unit.

Recording

DVD mode VCR mode

This unit is compatible with DVD+RW/DVD-RW, which is rewritable repeatedly and DVD+R/DVD-R, which is available for recording once. Even if you choose DVD-RW/DVD-R, these discs will automatically be recorded in the DVD+VR mode. Also, this unit allows you to record to the cassette tape. You can choose either one for your convenience.

Up to 12 program recording:

You can program the unit to record up to 12 programs within a one-month period. Daily or weekly program recordings are also available.

One-touch timer recording (OTR):

You can easily set a recording time as you prefer. Every time [RECORD ●] or [REC ●] is pressed during recording, the recording time will be increased by 30 minutes up to 6 hours for DVD, and 8 hours for VCR. The recording automatically stops when the recording time you set is reached or the disc and the cassette tape is full.

Dubbing mode:

You can copy a DVD disc to a cassette tape or copy a cassette tape to a DVD disc. This function will be possible only if the DVD disc or a cassette tape is not copy protected. You cannot record on a cassette tape when its erase-protection tab is removed.

Left channel stereo recording:

This unit can record the sound of the left channel monaural input as left and right channels automatically.

Automatic chapter mark setting:

Chapter marks will be put on recordings as you set before attempting to record.

Automatic title list making:

The unit makes a title list with the index automatically.

Playback

Theater surround sound in your home:

When connecting the unit to an amplifier or a decoder which is compatible with Dolby Digital, you can experience the theater surround sound from discs with surround sound system.

Quick search for what you want to watch:

You can easily find the part you want to watch using the search function. Search for a desired point on a disc by title, chapter or time.

Virtual surround system:

You can enjoy stereophonic space through your existing 2 channel stereo system.

Playing back MP3 files:

You can enjoy MP3 files which are recorded on CD-RW/R.

Quick search for what you want to watch:

You can easily find the part you want to watch using the index search/time search functions. An index mark will be assigned at the beginning of each recording you make. For time search function, you can go to a specific point on a cassette tape by entering the exact amount of time you wish to skip.

Editing

Deleting titles:

You can delete titles which you do not need anymore.

Putting names on titles:

You can put your favorite names on titles.

Setting / clearing chapter marks:

You can set / clear chapter marks on titles.

Hiding chapters:

To keep others from playing back some chapters without permission, you can hide chapters.

Setting pictures for thumbnails:

You can change pictures for thumbnails.

Dividing titles (DVD+RW/DVD-RW only):

You can divide a title into 2 or more.

Putting name on disc:

You can put your favorite disc name.

Compatibility

DVD mode

Available for playing back discs on a regular DVD player:

Recorded discs can be played back on regular DVD players, including computer DVD drives compatible with DVD-video playback. Although DVD+R are playable on other units without finalization in most cases, it is recommended to finalize in order to stabilize the performance. For DVD-RW/DVD-R, you need to finalize the recorded discs to play back on other DVD players.

Others

Line through output

When an external device, such as cable/satellite box, is connected to E1(Rear) jacks of this unit, the signal from the external device can be output even when the power of the unit is off.

Progressive scan system

Unlike conventional interlace scanning, the progressive scan system provides less flickering and images in higher resolution than that of traditional television signals.

HDMI (High-Definition Multimedia Interface)

You can enjoy clearer audio/video output when connecting this unit to a display device with an HDMI-compatible port.

Symbols Used in this Owner's Manual

To specify for what disc type each function is, we put the following symbols at the beginning of each item to operate.

- * DVD-RW/-R recorded in VR mode or non compatible recording format are not playable.
- * DVD-RW recorded in the mode other than +VR is not recordable on this unit unless you erase all contents in the disc (refer to page 68).
- * DVD-R recorded in the mode other than +VR is not recordable on this unit.

Symbol Description

For Recording, Playing Back, and Editing

 Description refers to DVD+RW

 Description refers to DVD+R

 Description refers to DVD-RW

 Description refers to DVD-R

 Description refers to VHS tapes
Use only cassettes marked VHS (VHS).

For Playback only

 Description refers to DVD-video

 Description refers to audio CD

 Description refers to video CD with PBC function

 Description refers to video CD without PBC function

 Description refers to CD-RW/-R with MP3 files

If you do not find any of the symbols listed above under the function heading, the operation is applicable to all media.

FUNCTIONAL OVERVIEW

Front Panel

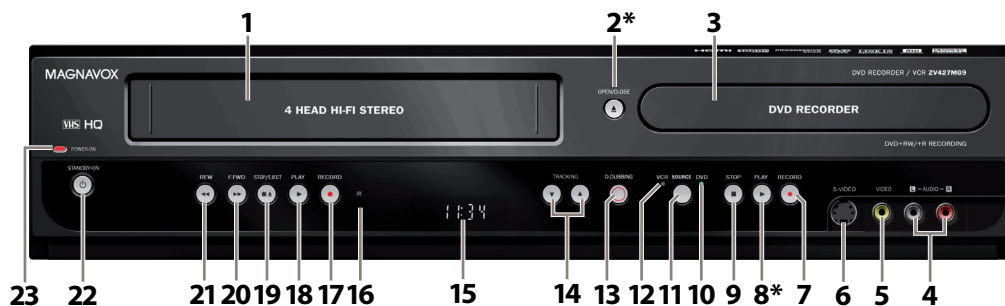

(*) The unit can also be turned on by pressing these buttons or insert a cassette tape.

- 1. Cassette compartment (VCR)**
Insert a cassette tape here.
- 2. OPEN/CLOSE ▲ button (DVD)***
Press to open or close the disc tray.
- 3. Disc tray (DVD)**
Place a disc when it is open.
- 4. AUDIO input jacks (E2) (DVD/VCR)**
Use to connect external device with an RCA audio cable.
- 5. VIDEO input jack (E2) (DVD/VCR)**
Use to connect external device with an RCA video cable.
- 6. S-VIDEO input jack (E2) (DVD/VCR)**
Use to connect the S-video output of external device with an S-video cable.
- 7. RECORD ● button (DVD)**
Press once to start recording.
Press repeatedly to start the one-touch timer recording.
- 8. PLAY ► button (DVD)***
Press to start or resume playback.
- 9. STOP ■ button (DVD)**
Press to stop playback or recording.
Press to stop the proceeding timer recording in DVD.
- 10. DVD indicator**
Lights up when the DVD output mode is selected.
- 11. SOURCE button (DVD/VCR)**
Press to select the component you wish to operate.
- 12. VCR indicator**
Lights up when the VCR output mode is selected.
- 13. D.DUBBING button (DVD/VCR)**
Press to start VCR to DVD (DVD to VCR) duplication which you set in the main menu.
- 14. TRACKING ▼ / ▲ buttons (VCR)**
Press to adjust the tracking during playback or in slow motion of the cassette tape.
While playback is in still mode, you can adjust the picture blurred vertically.
- 15. Display**
Refer to "Front Panel Display" on page 12.
- 16. Infrared sensor window (DVD/VCR)**
Receive signals from your remote control so that you can control the unit from a distance.
- 17. RECORD ● button (VCR)**
Press once to start a recording. Press repeatedly to start the one-touch timer recording.
- 18. PLAY ► button (VCR)**
Press to start playback.
- 19. STOP ■ / EJECT ▲ button (VCR)**
EJECT ▲ button
When the unit is in stop mode, press to remove the cassette tape from the cassette compartment.
STOP ■ button
Press to stop cassette tape playback or recording.
Press to stop the proceeding timer recording in VCR.
- 20. F.FWD ►► button (VCR)**
Press to rapidly advance the cassette tape, or view the picture rapidly in forward during playback (forward search).
- 21. REW ◀◀ button (VCR)**
Press to rewind the cassette tape, or to view the picture rapidly in reverse during playback (rewind search).
- 22. STANDBY-ON ☉ button (DVD/VCR)**
Press to turn on and off the unit.
- 23. POWER ON indicator (DVD/VCR)**
Red LED lights up when power is on.

Rear Panel

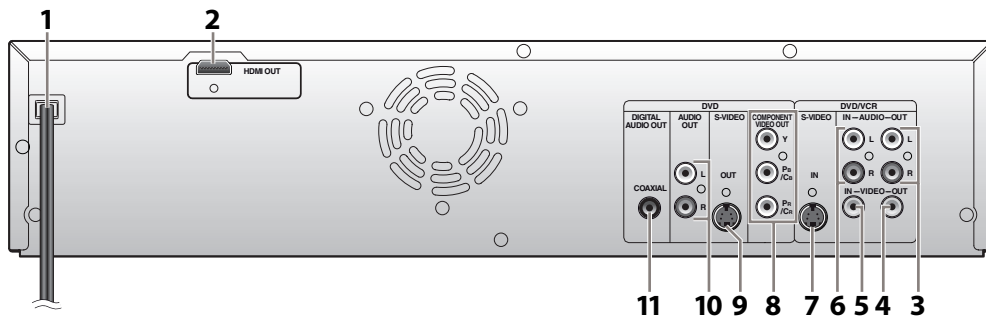

1. AC Power Cord (DVD/VCR)

Connect to a standard AC outlet to supply power to this unit.

2. HDMI OUT jack (DVD only)

Use an HDMI cable to connect to a display with an HDMI compatible port.

3. AUDIO OUT jacks (DVD/VCR)

Use to connect a TV monitor, AV receiver or other device with an RCA audio cable.

4. VIDEO OUT jack (DVD/VCR)

Use to connect a TV monitor, AV receiver or other device with an RCA video cable.

5. VIDEO IN jack (E1) (DVD/VCR)

Use to connect external device with an RCA video cable.

6. AUDIO IN jacks (E1) (DVD/VCR)

Use to connect external device with an RCA audio cable.

7. S-VIDEO IN jack (E1) (DVD/VCR)

Use to connect the S-video output of external device with an S-video cable.

8. COMPONENT VIDEO OUT jacks (DVD only)

Use to connect a TV monitor with component video inputs with a component video cable.

9. S-VIDEO OUT jack (DVD only)

Use to connect the S-video input of a TV monitor, AV receiver or other device with an S-video cable.

10. AUDIO OUT jacks (DVD only)

Use to connect a TV monitor, AV receiver or other device with an RCA audio cable.

11. COAXIAL DIGITAL AUDIO OUT jack (DVD only)

Use to connect an AV receiver, Dolby Digital decoder or other device with a coaxial digital input jack with a digital coaxial cable.

Note

- Do not touch the inner pins of the jacks on the rear panel. Electrostatic discharge may cause permanent damage to the unit.

FUNCTIONAL OVERVIEW

Remote Control

Installing the Batteries in the Remote Control

Install the batteries (AAAx2) matching the polarity indicated inside battery compartment of the remote control.

1 Open the cover.

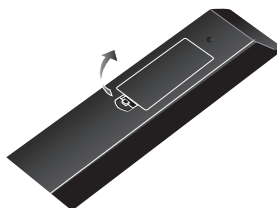

2 Insert batteries.



Make sure to match + and - on the batteries to the marks indicated in the battery compartment.

3 Close the cover.



Note

Incorrect use of batteries can result in hazards such as leakage and bursting. Please observe the following:

- Do not mix new and old batteries together.
- Do not use different kinds of batteries together. Although they may look similar, different batteries may have different voltages.
- Make sure that the + and - ends of each battery match the indications in the battery compartment.
- Remove batteries from battery compartment that is not going to be used for a month or more.
- When disposing of used batteries, please comply with governmental regulations or environmental public instruction's rules that apply in your country or area.
- Do not recharge, short-circuit, heat, burn or disassemble batteries.

Using a Remote Control

Keep in mind the following when using the remote control:

- Make sure that there are no obstacles between the remote control and the infrared sensor window on the unit.
- Remote operation may become unreliable if strong sunlight or fluorescent light is shining on the infrared sensor window of the unit.
- Remote control for different devices can interfere with each other. Avoid using remote control for other device located close to the unit.
- Replace the batteries when you notice a fall off in the operating range of the remote control.
- The maximum operable ranges from the unit are as follows.
 - **Line of sight:** approx. 23 feet (7m)
 - **Either side of the center:** approx. 16 feet (5m) within 30°
 - **Above:** approx. 16 feet (5m) within 15°
 - **Below:** approx. 10 feet (3m) within 30°



16feet (5m) 30° 23feet (7m) 16feet (5m) 30°

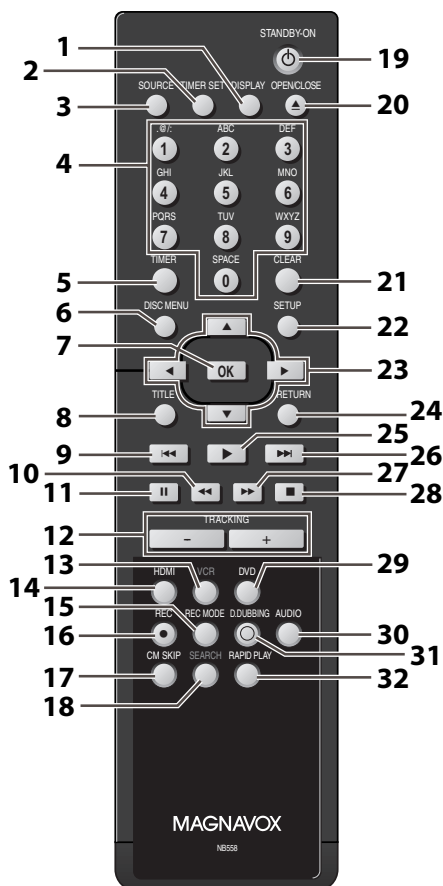

FUNCTIONAL OVERVIEW

- 1. DISPLAY button (DVD/VCR)**
 - Press to display the display menu on or off.
- 2. TIMER SET button (DVD/VCR)**
 - Press to set the unit in the timer standby mode. In the timer standby mode, press to cancel the mode and to turn the unit on.
- 3. SOURCE button (DVD/VCR)**
 - Press to select the appropriate input.
- 4. Number/Character buttons (DVD/VCR)**
 - Press to select a title/chapter/track/file on display.
 - Press to enter values for the settings in the main menu.
 - Press to enter title names.
 - Press to start the index/time search in VCR mode.
- 5. TIMER button (DVD/VCR)**
 - Press to display the timer programming list.
- 6. DISC MENU button (DVD)**
 - Press to display the disc menu.
- 7. OK button (DVD/VCR)**
 - Press to confirm or select menu items.
- 8. TITLE button (DVD)**
 - Press to display the title list.
- 9. PREV ◀◀ button (DVD)**
 - During playback, press to return to the beginning of the current chapter, track or file.
 - When playback is paused, press to play back reverse step by step.
- 10. REW ◀◀ button (DVD/VCR)**

DVD mode:

 - During playback, press to fast reverse.
 - When playback is paused, press to play back slow reverse.

VCR mode:

 - During playback, press to rewind the cassette tape or to view the picture rapidly in reverse.
- 11. PAUSE || button (DVD/VCR)**
 - Press to pause playback or recording.
- 12. TRACKING + / - buttons (VCR)**
 - Press to adjust the tracking during playback or in slow motion of the cassette tape.
 - While playback is in still mode, you can adjust the picture blurred vertically.
- 13. VCR button**
 - Press to select the VCR output mode.
- 14. HDMI button (DVD)**
 - Press to set the HDMI connector's video signal output mode.
- 15. REC MODE button (DVD/VCR)**
 - Press to switch the recording mode.
- 16. REC ● button (DVD/VCR)**
 - Press once to start a recording.
 - Press repeatedly to start the one-touch timer recording.
- 17. CM SKIP button (DVD)**
 - During playback, press to skip 30 seconds.
- 18. SEARCH button (VCR)**
 - Press to call up the index or time search menu.
- 19. STANDBY-ON Ⓞ button (DVD/VCR)**
 - Press to turn the unit on and off.
- 20. OPEN/CLOSE ▲ button (DVD/VCR)**

DVD mode:

 - Press to open or close the disc tray.

VCR mode:

 - Press to remove the cassette tape from the cassette compartment.
- 21. CLEAR button (DVD/VCR)**

DVD mode:

 - Press to clear the password once entered or to cancel the programming for CD or to clear the selecting marker number in the edit menu, etc.

VCR mode:

 - Press to reset the tape counter.
- 22. SETUP button (DVD/VCR)**
 - Press to display the main menu.
 - During DVD playback, press and hold for more than 3 seconds to switch the progressive scanning mode to the interlace mode.
- 23. Cursor ▲ / ▼ / ◀ / ▶ buttons (DVD/VCR)**
 - Press to select items or settings.
- 24. RETURN button (DVD/VCR)**
 - Press to return to the previously displayed menu screen.
- 25. PLAY ▶ button (DVD/VCR)**
 - Press to start or resume playback.
- 26. NEXT ▶▶ button (DVD)**
 - During playback, press to skip to the next chapter, track or file.
 - When playback is paused, press to play back forward step by step.
- 27. FFW ▶▶ button (DVD/VCR)**

DVD mode:

 - During playback, press to play back fast forward.
 - When playback is paused, press to play back slow forward.

VCR mode:

 - During playback, press to rapidly advance the cassette tape or view the picture rapidly in forward.
 - When playback is paused, press to view the cassette tape in slow motion.
- 28. STOP ■ button (DVD/VCR)**
 - Press to stop playback or recording.
 - Press to exit from the title list.
- 29. DVD button**
 - Press to select the DVD output mode.
- 30. AUDIO button (DVD/VCR)**

DVD mode:

 - During playback, press to display the audio menu.

VCR mode:

 - During playback a HiFi video tape, press to change the audio out setting HiFi and mono.
- 31. D.DUBBING button (DVD/VCR)**
 - Press to start VCR to DVD (DVD to VCR) duplication which you set in the main menu.
- 32. RAPID PLAY button (DVD)**
 - During playback, press to playback in a slightly faster/slower mode while keeping the sound output.

Note

- If you turn off this unit, [OPEN/CLOSE ▲] on the remote control is not available. Be sure to use [OPEN/CLOSE ▲] or [STOP ■ / EJECT ▲] on the unit.

FUNCTIONAL OVERVIEW

Front Panel Display

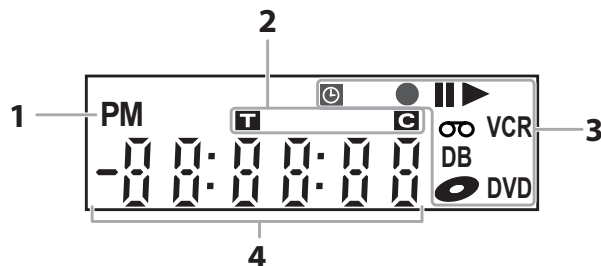

1.

PM : Appears in the afternoon with the clock display.

2. Title / track / file and chapter mark

T : Appears when indicating a title / track / file number.

C : Appears when indicating a chapter number.

3. Current status of the unit

|| : Appears when playback is paused.

▶ : Appears when playing back a disc.

⌚ : Appears when the timer programming or OTR has been set and is proceeding.

: Flashes when all timer recordings have been finished.

● : Appears during recording process.

: Flashes when a recording pauses.

○ : Appears when this unit is in DVD output mode and a disc is in the unit.

: Appears during duplication process.

∞ : Appears when this unit is in VCR output mode and a cassette tape is in the unit.

: Appears during duplication process.

VCR : Appears when this unit is in VCR output mode.

: Appears when the timer recording is proceeding in VCR.

: Appears when VCR is in the timer recording standby mode.

: Flashes when a program cannot be performed for some reasons.

DVD : Appears when this unit is in DVD output mode.

: Appears when the timer recording is proceeding in DVD.

: Appears when DVD is in the timer recording standby mode.

: Flashes when a program cannot be performed for some reasons.

DB : Appears during VCR to DVD duplication process.

: Appears during DVD to VCR duplication process.

4. Displays the following

- Elapsed playback time
- Current title / chapter / track / file number
- Recording time / remaining time
- Clock
- Selected external input position
- Remaining time for one-touch timer recording
- Selected HDMI output mode

Display Message



Appears when the disc tray is opening.



Appears when HDMI output mode (480p) is selected.



Appears when the disc tray is closing.



Appears when HDMI output mode (720p) is selected.



Appears when a disc is loaded on the disc tray.



Appears when HDMI output mode (1080i) is selected.



Appears when data is being written on a disc.



Appears when HDMI output mode (1080p) is selected.



Appears when the PBC function is activated. (Video CD playback only. Refer to page 42.)

CONNECTION TO AN EXTERNAL TUNER

This section describes how to connect this unit to an external tuner such as cable/satellite box.

- When you change the connections, all devices should be turned off.
- Refer to the manual accompanying external devices for more information.

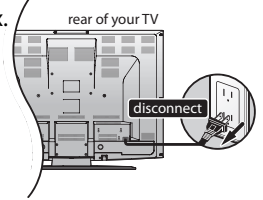

1 Disconnect the power cords of the devices from the AC outlet.

2 Make the connection as illustrated below.

e.g.)

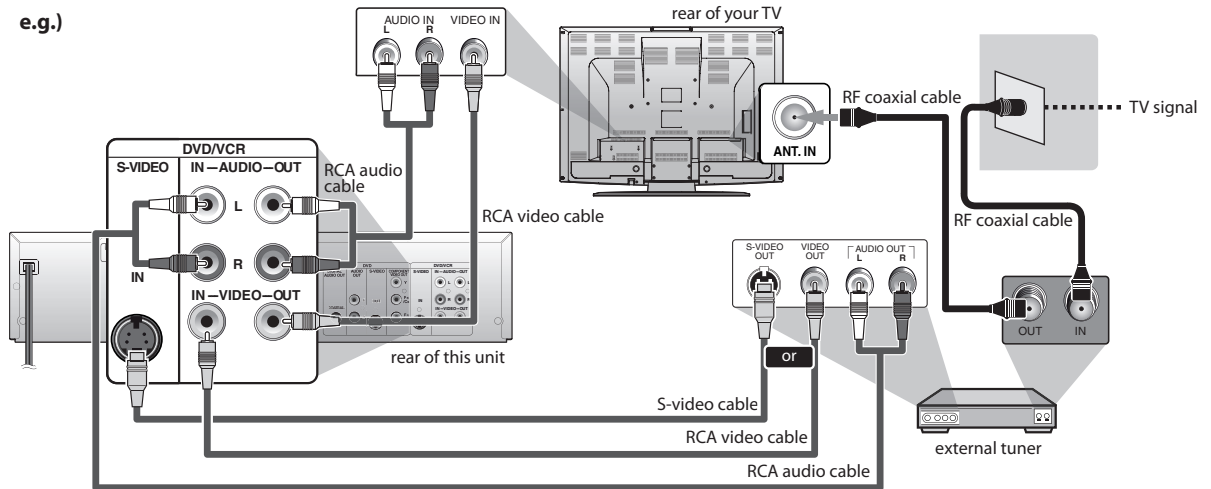

Supplied cables used in this connection are as follows:

- RCA audio cable (L/R) x 1
- RCA video cable x 1

Please purchase the rest of the necessary cables at your local store.

Note

- Required cables and connecting methods differ depending on the external tuner. For more information, please contact your external tuner provider.
- Instead of using VIDEO OUT jack of this unit, you can also use S-VIDEO OUT jack, COMPONENT VIDEO OUT jack, or HDMI OUT jack (no AUDIO OUT jack connection required) for connecting to your TV.

With this setup:

- You can record any unscrambled channel by selecting the channel on the external tuner. Be sure that the external tuner is turned on.
- Signal from the external tuner can be output only on CVBS output even when the power of the unit is off.
- **You cannot record one channel while watching another channel.**

3 Plug in the power cords of the devices to the AC outlet.

4 After making the connection as described above, make sure to select the appropriate video input type by following the steps in "SETTINGS FOR THE VIDEO INPUT" on page 15.

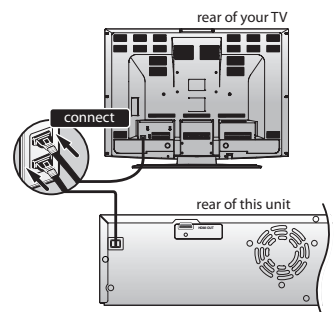

Note to CATV system installer

- This reminder is provided to call the cable TV system installer's attention to Article 820-40 of the National Electrical Code, which provides guidelines for proper grounding - in particular, specifying that the cable ground shall be connected to the grounding system of the building, as close to the point of cable entry as possible.

CONNECTION TO AN EXTERNAL DEVICE

Connect the external device properly to either E2 (front) or E1 (rear) input jacks of this unit by using S-video or RCA audio / video cables.

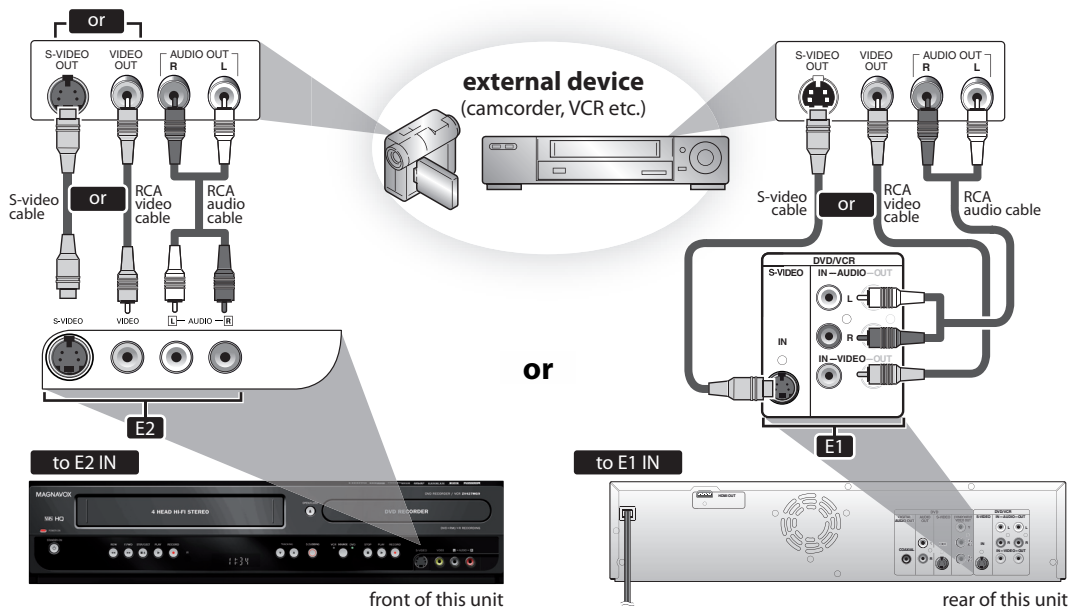

After making the connection as described above, make sure to select the appropriate video input type by following the steps in "SETTINGS FOR THE VIDEO INPUT" on page 15.

Supplied cables used in this connection are as follows:

- RCA audio cable (L/R) x 1
- RCA video cable x 1

Please purchase the rest of the necessary cables at your local store.

Note

- When connecting an external device of monaural output to this unit, use AUDIO L jack of E2 (Front).

SETTINGS FOR THE VIDEO INPUT

You must let the unit know which video input jack you are using before making a recording.



1 Press [SETUP] and use [▲ / ▼] to select “General Setting”, then press [OK].

“General Setting” menu will appear.

2 Use [▲ / ▼] to select “Video”, then press [OK].

Submenu will appear.

3 Use [▲ / ▼] to select “Video Input”, then press [OK].

4 Use [▲ / ▼] to select desired external input position, then press [OK].

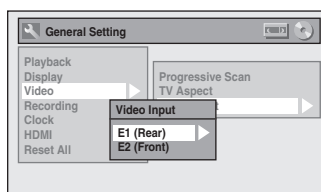

5 Use [▲ / ▼] to select the input jack type to connect, then press [OK].

If you want to use VIDEO IN jack, select “Video In”.

If you want to use S-VIDEO IN jack, select “S-Video In”.

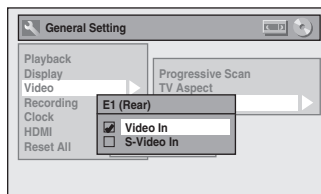

6 Press [SETUP] to exit.

CONNECTION TO A TV

Make one of the following connections, depending on the capabilities of your existing device.

VCR and basic DVD connection

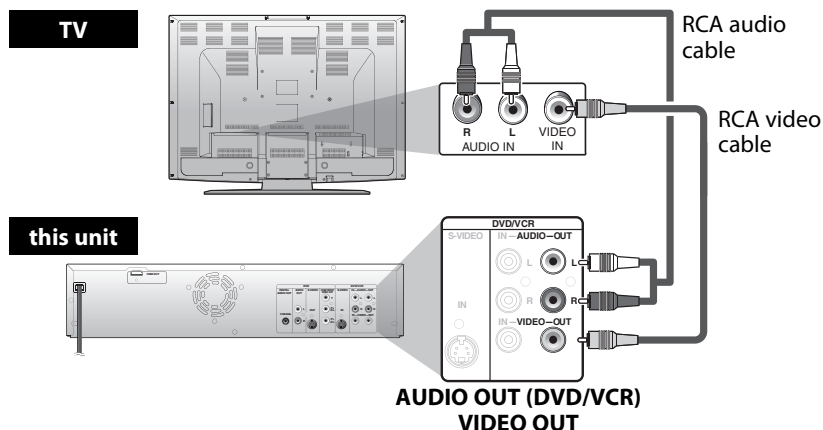

Available on DVD only

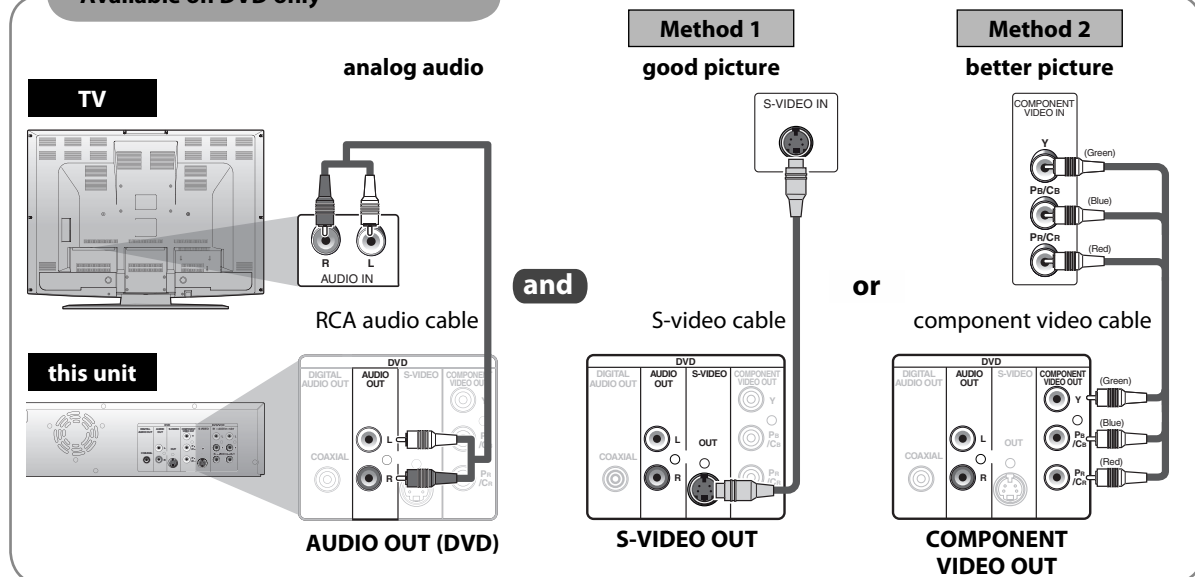

Supplied cables used in this connection are as follows:

- RCA audio cable (L/R) x 1
- RCA video cable x 1

Please purchase the rest of the necessary cables at your local store.

After you have completed the connections

- Switch the input selector on your TV to an appropriate external input channel. Press a button on the TV's original remote control that selects an external input channel until the DVD recorder's opening picture appears. Check your TV's manual for details.

Note

- Connect this unit directly to the TV. If the RCA audio/video cables are connected to a VCR, pictures may be distorted due to the copy protection system.
- You will not be able to hear the sound being output from DVD if you are not connecting DVD AUDIO OUT when you made either S-video or component video out connection.
- **When "Progressive Scan" is set to "ON", no video signal will be output from the VIDEO OUT or S-VIDEO OUT jack.**

To set progressive scan mode, refer to page 76

- This unit is compatible with the progressive scan system. The feature provides you with the higher definition images than the traditional output system does. To utilize this feature, you must set "Progressive Scan" to "ON".

CONNECTION TO A TV WITH AN HDMI™ COMPATIBLE PORT

A simple 1-cable connection with a device having an HDMI (high-definition multimedia interface) connector allows digital transfer of both digital video signals and multi-channel audio signals.

Available for DVD only

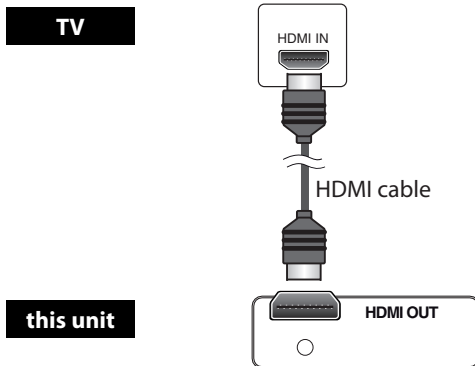

When connecting with an HDMI cable, the audio signal will be output as the digital audio signal simultaneously, so you do not need the analog audio connection described on page 16.

Cables not included.

Please purchase the necessary cables at your local store.

Actual Output Modes by Media

Audio recording format of the disc		Dolby Digital setting of this unit	Actual output
DVD-video	Dolby Digital	PCM	2channel PCM
		Stream	Dolby Digital
	LPCM	PCM	2channel PCM
		Stream	

For audio CD and MP3 files, 2 channel PCM will be output regardless of the "Dolby Digital" setting.

If the connected device is not compatible with HDMI BITSTREAM, audio will be output as PCM even if you select "Stream" in "Dolby Digital" setting (Refer to page 70).

Copyright protection system

To play back the digital video images of a DVD via an HDMI connection, it is necessary that both the player and the display device (or an AV amplifier) support a copyright protection system called HDCP (high-bandwidth digital content protection system). HDCP is copy protection technology that comprises data encryption and authentication of the connected AV device. This unit supports HDCP. Please read the operating instructions of your display device (or AV amplifier) for more information.

*HDMI: High Definition Multimedia Interface

Note

- Because HDMI is an evolving technology, it is possible that some devices with an HDMI input may not operate properly with this unit.
- When using an HDCP-incompatible display device, the image will not be viewed properly.
- Among the devices that support HDMI, some devices can control other devices via the HDMI connector; however, this unit cannot be controlled by another device via the HDMI connector.
- The audio signals from the HDMI connector (including the sampling frequency, the number of channels and bit length) maybe limited by the device that is connected.
- Among the monitors that support HDMI, some do not support audio output (for example, projectors). In connections with device such as this unit, audio signals are not output from the HDMI output connector.
- When this unit's HDMI connector is connected to a DVI-D compatible monitor (HDCP compatible) with an HDMI-DVI converter cable, the signals are output in digital RGB.
- When the power failure occurs, or when you unplug the unit, some problems in the HDMI setting might occur. Please check and set the HDMI setting again.
- When the unit is connected with an HDMI cable, a revocation list update screen may appear when you try to play back the DVD-video containing a revocation list.
- If the unit is connected to the unauthorized display device with an HDMI cable, the audio/video signal may not be output when playing back a commercial DVD-video.

HDMI Mode and Actual Output Signals

Press [HDMI] to select the HDMI output mode. The output mode changes as follows every time [HDMI] is pressed.

Front Panel Display	Video Output Signal
400P	480 Progressive
Press [HDMI]	↓
720P	720 Progressive
Press [HDMI]	↓
1000i	1080 interlaced
Press [HDMI]	↓
1000P	1080 Progressive
Press [HDMI]	

- The HDMI mode that is not supported by display device will be skipped.

CONNECTION TO AN AUDIO SYSTEM

2 Channel Analog Audio Connection

Digital Audio Connection

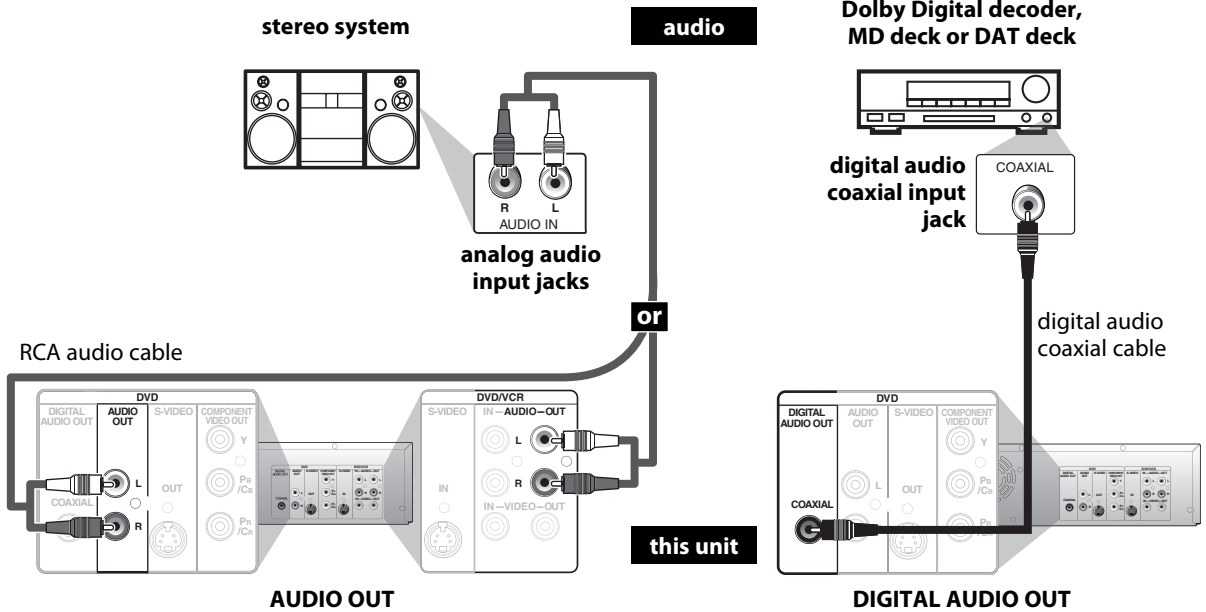

Supplied cables used in this connection are as follows:

- RCA audio cable (L/R) x 1
- Please purchase the rest of the necessary cables at your local store.

Connection	Setting	Setup > General Setting > Playback > Disc Audio > Dolby Digital
If output is Dolby Digital encoded audio, connect to a Dolby Digital decoder.		Stream
Connecting to an MD deck or DAT deck.		PCM
If not connected to any external devices.		PCM

* To complete these settings, refer to page 74.

Note

- The DVD AUDIO OUT and DIGITAL AUDIO OUT jacks are only useful in DVD mode.
- The audio source on a disc in a Dolby Digital multi channel surround format cannot be recorded as digital sound by an MD or DAT deck.
- By connecting this unit to a Dolby Digital decoder, you can enjoy high-quality Dolby Digital multi channel surround sound as heard in the movie theaters.
- Playing back a DVD using incorrect settings may generate noise distortion and may also damage the speakers.

THE DVD / VCR RECORDER SWITCHING

Because this product is a combination of a VCR and a DVD recorder, you must select first which component you wish to operate with **[SOURCE]** on the unit.

DVD mode

Press **[DVD]** on the remote control.
(Verify that the DVD indicator is lit.)

VCR mode

Press **[VCR]** on the remote control.
(Verify that the VCR indicator is lit.)

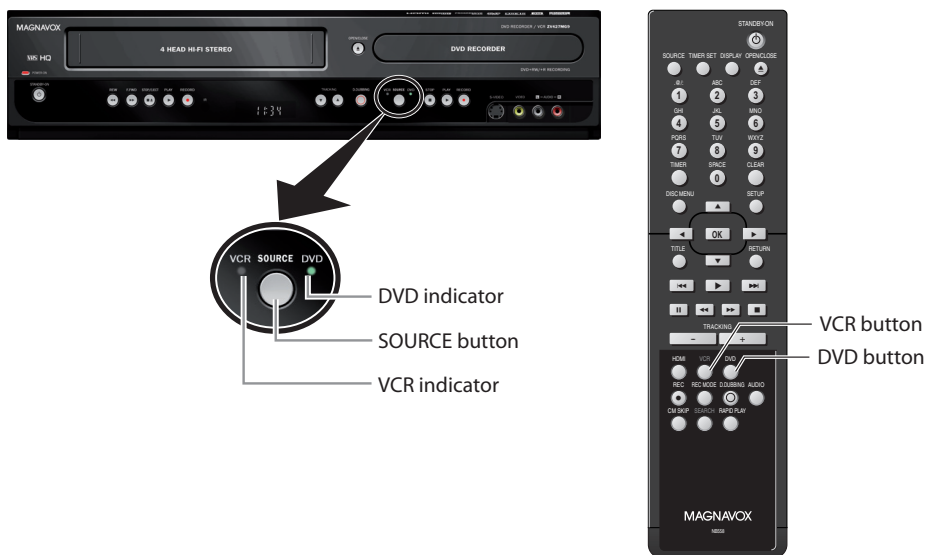

Note

- You cannot switch to another mode (DVD or VCR) during in the timer-standby mode.

GUIDE TO ON-SCREEN DISPLAYS AND MENUS

This unit uses the following on-screen displays and menus to guide you to the easy operations. The on-screen displays give you the information on the loaded disc, the disc/file in playback, or the HDMI status, etc. The menus allow you to change the various kinds of settings for playing back, recording, or editing to suite your preference.

On-Screen Display / Menu

The on-screen display changes in the following order as you press [DISPLAY].

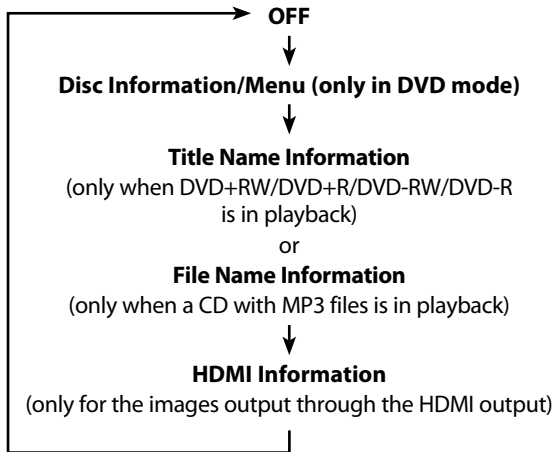

Disc Information / Menu

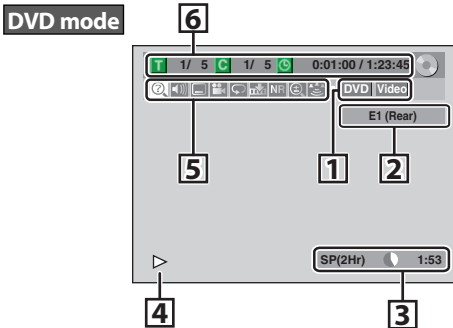

* This is an example screen only for explanation.

1. Indicates a disc type and format mode.
2. Indicates the selected external input position.
3. Indicates a recording mode and possible recording time left.
4. Indicates an operation status.
5. Each icon means:



6. Indicates the current title number/total number of titles, the current chapter number/total number of chapters, and time lapse of the current title playback/total duration of the title.

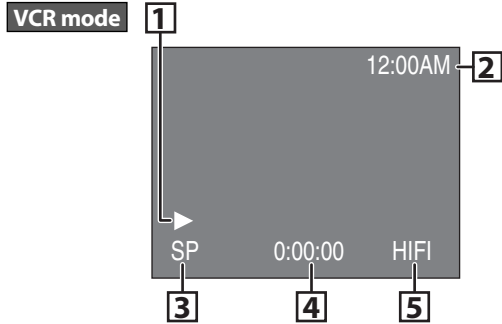

1. Indicates current video status.
2. Indicates the current time.
3. Indicates a recording or playing back mode.
4. Indicates a tape counter.
5. Audio status of the current cassette tape.

Note

- This is an example screen only for explanation. Displayed items are depending on the disc you inserted.

Title/File Name Information

Title Name Information

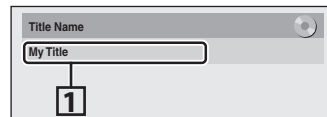

File Name Information

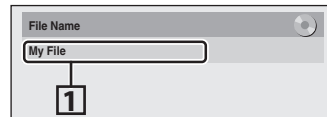

1. Displays title/file name.

HDMI Information

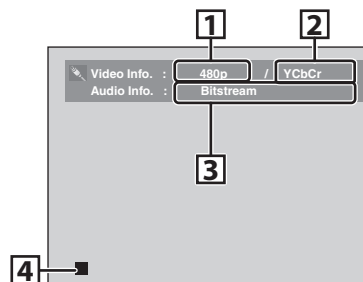

- *1. Indicates the resolution of the HDMI output image.
 - *2. Indicates the HDMI video format.
 - *3. Indicates the HDMI audio format.
 4. Indicates current disc status.
- * "- - -" will be displayed, when it does not have any information.

Main Menu

Press **[SETUP]** to display the main menu. Then use **[▲ / ▼]** to select a menu and press **[OK]** to display the menu. These menus provide entries to all main functions of the unit.

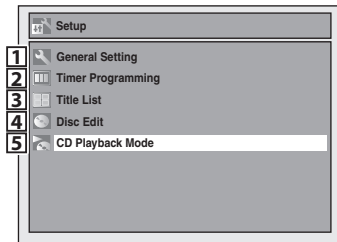

1. General Setting:

To go to general setting menu.

2. Timer Programming:

To program a timer recording.

3. Title List:

To call up the title list.

4. Disc Edit:

To set up the DVD disc setting.

5. CD Playback Mode:

To set up the CD playback setting.

- "CD Playback Mode" is available only when an audio CD, a video CD, a CD-RW/-R with MP3 files is inserted into the unit.

General Setting Menu

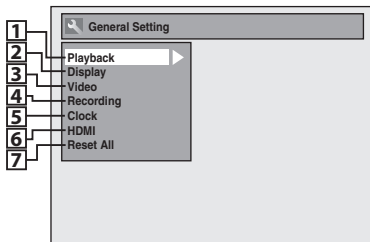

1. Playback:

To set up the unit to play back discs as you prefer.

2. Display:

To set up the OSD screen as you prefer.

3. Video:

To set up the video setting.

4. Recording:

To set up the unit to record to discs as you prefer.

5. Clock:

To set up the clock of the unit as you need.

6. HDMI:

To set up the HDMI connection setting.

7. Reset All:

To reset the setting to the factory default.

Disc Edit / CD Playback Mode

<Disc Edit menu (DVD+RW)>

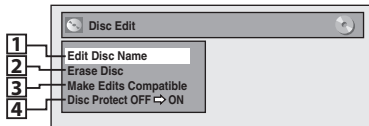

<Disc Edit menu (DVD-RW)>

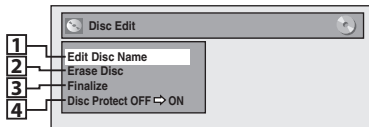

<Disc Edit menu (DVD+R/DVD-R)>

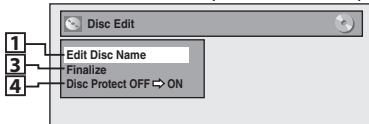

<CD Playback Mode menu>

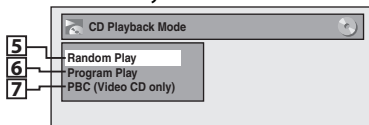

1. Edit Disc Name:

Allows you to rename the disc.

2. Erase Disc: (DVD+RW/DVD-RW only)

Allows you to erase all contents in the disc and format it.

3. Make Edits Compatible: (DVD+RW only)

Allows you to memorize the editing status on the disc if you have added or deleted chapters, or made chapters hidden on this unit, and to effect it when playing back on the other unit.

Finalize: (DVD+R/DVD-RW/-R only)

Allows you to finalize a disc containing recorded titles.

4. Disc Protect :

Allows you to protect a disc from accidental editing or recording.

5. Random Play:

Allows you to activate the random playback feature.

6. Program Play: (audio CD/video CD only)

Allows you to activate the program playback feature.

7. PBC (Video CD only):



Allows you to select images or information on the menu screen by activating PBC (playback control) function.

INITIAL SETTING

You need to follow these steps when you turn on this unit for the first time.



1 Press [STANDBY-ON ].
Turn on the TV. Select the input to which the unit is connected.

2 Use [ / ] to select your desired language, then press [OK] to set language.

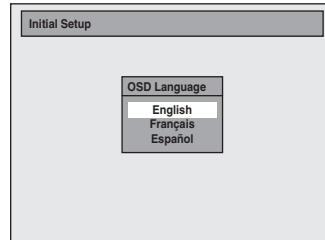

3 Press [OK] to activate "Clock Setting".

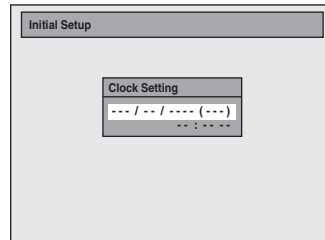

4 Proceed to step 4 in "Clock Setting" on page 23.

Input Mode Names for Common TV Brands (Example)

Admiral	AUX	Panasonic	TV/VIDEO
Curtis Mathis	LINE1, LINE2, 00, 90, 91, 92, 93	RCA	INPUT, TV/VCR, 00, 90, 91, 92, 93
GE	INPUT, TV/VCR, 00, 90, 91, 92, 93	Samsung	TV/VIDEO
Hitachi	INPUT, AUX	Sanyo	VIDEO
JVC	VIDEO, VIDEO 1, VIDEO 2, VIDEO 3	Sharp	00
Kenwood	AUX	Sony	VIDEO1, VIDEO2, VIDEO3
LXI-Series	00	Toshiba	TV/GAME
Magnavox	AUX CHANNEL	Zenith	00

SETTING THE CLOCK

Set the clock before you try the timer programming.

Clock Setting



1 Press [SETUP] and use [▲ / ▼] to select "General Setting", then press [OK].

"General Setting" menu will appear.

2 Use [▲ / ▼] to select "Clock", then press [OK].

3 Use [▲ / ▼] to select calendar or time, then press [OK].

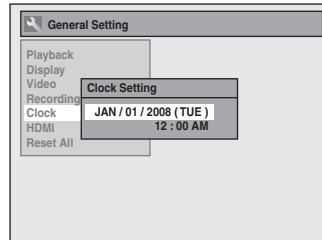

4 Use [◀ / ▶] to select an item to set, and use [▲ / ▼] to select the contents to suit your preference, then press [OK].

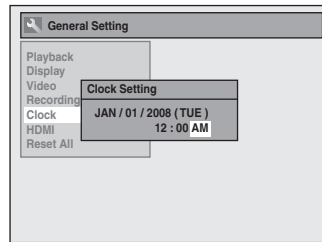

Your setting will be activated.

The clock start counting when you press [OK].

5 Press [SETUP] to exit.

Note





- Your clock setting will be lost if either there is a power failure or this unit has been unplugged for more than 30 seconds.
- For setting the day, year, hour, and minute, **[the Number buttons]** can also be used.
- You can set the built-in calendar from the year 2007 up to 2056.

INFORMATION ON DVD RECORDING

Before you make a recording, read the following information.

Recordable Discs

This unit can record to DVD+RW, DVD+R, DVD-RW and DVD-R.
 DVD+R/DVD-R can only be recorded to once. DVD+RW/DVD-RW can be recorded to and erased many times.
DVD-RW/-R will be recorded in the DVD+VR mode automatically in this unit.

Logo	Attributes
 DVD+ReWritable DVD+RW	8cm/12cm, single-sided, single layer disc Approx. max. recording time (SLP mode): 360 minutes (4.7GB) (for 12cm) 108 minutes (1.4GB) (for 8cm)
 DVD+R DVD+R	
 DVD-RW DVD-RW	
 DVD-R DVD-R	

• Following discs are recommended for good recording quality and are proven to be compatible with this unit. However, depending on the media condition the unit may not read the disc properly.

Verbatim	DVD+R 8x,	DVD+RW 4x,
	DVD-R 8x,	DVD-RW 2x
JVC	DVD-RW 4x	
Maxell	DVD+R 4x/8x/16x,	DVD-R 8x/16x
SONY	DVD+R 4x/8x/16x,	DVD+RW 4x
TDK	DVD+R 4x/8x/16x	

Performance of any other discs are not guaranteed.

• **You can play back DVD+RW on most DVD players without finalizing. However, if you have added or deleted chapters, or made chapters hidden, you must perform "Make Edits Compatible" before being able to see those effects on other units. (Refer to page 69 for more details.) To play back discs other than DVD+RW on other DVD players, you will need to finalize.**

Unrecordable Discs

- DVD-RW recorded in the mode other than +VR is not recordable on this unit unless you erase all contents in the disc (refer to page 68).
- DVD-R recorded in the mode other than +VR is not recordable on this unit.

Recording Mode

You can select a recording mode among 6 options, and the recording time will depend on the recording mode you select as follows.

Disc size	Recording mode	Recording time	Video/sound quality
8cm Disc	HQ (1Hr)	18 min	☆☆☆☆☆☆ (good)
	SP (2Hr)	36 min	☆☆☆☆☆
	SPP (2.5Hr)	45 min	☆☆☆☆
	LP (3Hr)	54 min	☆☆☆
	EP (4Hr)	72 min	☆☆
	SLP (6Hr)	108 min	☆ (poor)
12cm Disc	HQ (1Hr)	60 min	☆☆☆☆☆☆ (good)
	SP (2Hr)	120 min	☆☆☆☆☆
	SPP (2.5Hr)	150 min	☆☆☆☆
	LP (3Hr)	180 min	☆☆☆
	EP (4Hr)	240 min	☆☆
	SLP (6Hr)	360 min	☆ (poor)

- The recording time is only an estimate. The actual recording time may differ.
- The audio and video quality gets poorer as the recording time becomes longer.
- Each time [REC MODE] is pressed, recording mode and its allowed recording time will be displayed.

Note

- **This unit cannot record to CD-RW or CD-R.**
- DVD+RW/+R, DVD-RW/-R and CD-RW/-R recorded on a personal computer or a DVD or CD recorder may not be played back if the disc is damaged or dirty or if there is condensation on the player's lens.
- If you record a disc using a personal computer, even if it is recorded in a compatible format it may not be played back because of the settings of the application software used to create the disc. (Check with the software publisher for more detailed information.)
- Since the recording is made by the VBR (variable bit rate) method, depending on the picture you are recording, the actual remaining time for recording may be a little shorter than the remaining time displayed on the TV screen.
- You cannot record copy-protected program using this unit. (Copy-protected signal is included in DVD-video or some satellite broadcasts.)
- You cannot record "copy-once only" program on DVD.

BEFORE RECORDING

Make Recording Compatible



Use this feature to make the unfinalized +VR mode discs recorded on other unit recordable on this unit. When you make an additional recording on this unit with "Make Recording Compatible" set to "ON", the title menu is automatically converted to our style.

- 1) Press [SETUP] and use [▲ / ▼] to select "General Setting", then press [OK].
"General Setting" menu will appear.
- 2) Use [▲ / ▼] to select "Recording", then press [OK].
"Recording" menu will appear.
- 3) Use [▲ / ▼] to select "Make Recording Compatible", then press [OK].
- 4) Use [▲ / ▼] to select "ON" or "OFF", then press [OK].

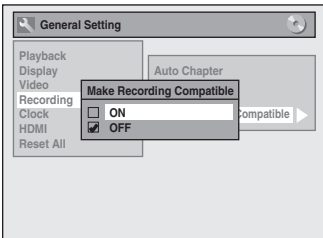

- ON:** Title list will be replaced when you make additional recordings to the discs recorded by other units.
- OFF:** Prohibiting additional record to the disc that has a title list created by other units.

- 5) Press [SETUP] to exit.

Setting for Auto Chapter

You can set a specified time for chapter marks.

- 1) Press [SETUP] and use [▲ / ▼] to select "General Setting", then press [OK].
"General Setting" menu will appear.
- 2) Use [▲ / ▼] to select "Recording", then press [OK].
"Recording" menu will appear.
- 3) Use [▲ / ▼] to select "Auto Chapter", then press [OK].
- 4) Use [▲ / ▼] to select a desired time option, then press [OK].

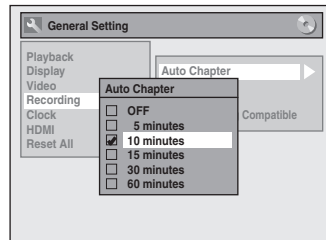

- 5) Press [SETUP] to exit.

Note

- The interval for auto chapter marks may slightly differ.
- A blank chapter may be created depending on the remaining time of the disc.

BASIC RECORDING & ONE-TOUCH TIMER RECORDING

Follow the steps to record TV programs from an external tuner.

This unit has no tuner system so cannot receive TV broadcasts without external tuner or such devices.

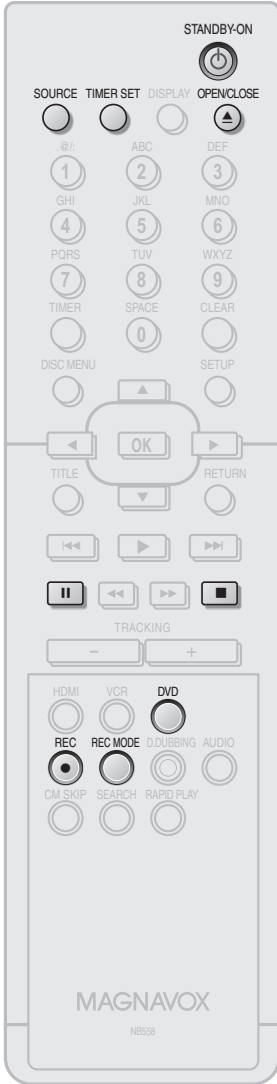

1 Press [STANDBY-ON ].
Turn on the TV and be sure to select the input to which the unit is connected.

Press [DVD].

2 Press [OPEN/CLOSE ] to open the disc tray and insert your disc with its label facing up.

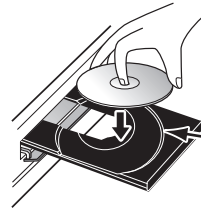

Align the disc to the disc tray guide.

* Make sure the disc is compatible with this unit.
(Refer to page 24 for the list of compatible discs.)

3 Press [OPEN/CLOSE ] to close the disc tray.

It may take a while to load the disc completely.

- When inserting a brand-new DVD+RW/DVD-RW, the unit automatically starts to format.
- If titles have been recorded on the disc, the title list is displayed. Press [STOP ] to exit the title list.

4 Press [REC MODE] to select a recording mode.

Refer to "Recording Mode" on page 24 for DVD.

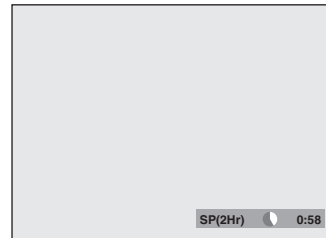

5 Press [SOURCE] to select the appropriate external input position (E1/E2) to which your external tuner is connected. Then select the desired channel to record on the external tuner.

6 Press [REC ●] to start recording. "●" will be displayed for 5 seconds.



Press [PAUSE III] to pause recording.
Press [PAUSE III] or [REC ●] again to restart recording.

To set one-touch timer recording (OTR)...

This is a simple way to set the recording time in blocks of 30 minutes.

Press [REC ●] repeatedly until the desired recording time (30 minutes to 6 hours) appears on the TV screen. One-touch timer recording will start.

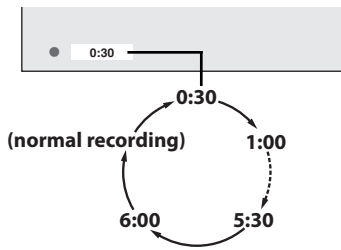

- To cancel one-touch timer recording within the specified time, press [STOP ■].

7 Press [STOP ■] to stop recording. The recorded title will appear in the title list. (Refer to "Guide to a Title List" on page 57.) e.g.) DVD+R

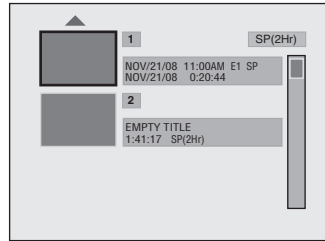
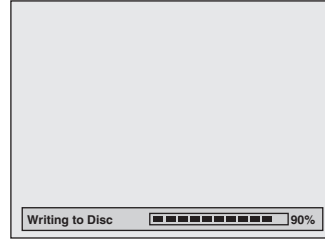

- Press [STOP ■] to exit the title list.

Note

- When you press [REC ●], recording starts immediately and continues until the disc is full or you stop recording.
- This unit cannot record images as aspect ratio of 16:9. The 16:9 images will be recorded as 4:3.
- When the unit clock has not been set, the space for a date and time of title names will be blank.
- You cannot change the recording mode during the recording pause mode.
- You can change a channel to be recorded during the recording pause mode.

Note for one-touch timer recording

- Press [DISPLAY] to see the remaining recording time on the TV screen.
- Unlike the timer recording, you can perform the following operations during one-touch timer recording.
 - Turning off the power to stop one-touch timer recording.
 - Using [REC ●] or [STOP ■] on the remote control.
- You cannot use the pause function during one-touch timer recording.
- If DVD one-touch timer recording is completed during VCR playback or recording, the DVD will be in stop mode and the VCR keeps the current mode.
- When one-touch timer recording is finished and the power is turned off, the unit will switch to the timer-standby mode automatically if a timer recording has been programmed. Press [TIMER SET] to cancel the timer-standby mode to use the unit continuously.

TIMER RECORDING

You can program the unit to record up to 12 programs within one month in advance. Daily or weekly program recordings are also available.

Before recording, make sure

- Connect the external tuner to either E1 or E2 and set it to output audio/video signals when it comes to the time you want to start recording.
- Do not change the external tuner's channel while you are recording. You cannot watch one channel and record another at the same time.
- Set the clock before setting a timer programming.
- Insert a recordable disc with enough recordable space or a cassette tape with an erase-protection tab.



Guide to Timer Programming Display

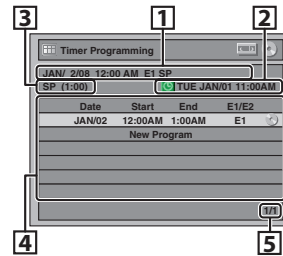

- 1 Title of a timer program (Contains date, time, selected external input position, recording mode of the program)
- 2 Current date and time
- 3 Recording mode, and length of the recording
- 4 Timer program list
- 5 Total number of pages and current page (2 pages maximum)

1 Press [TIMER].

2 Use [▲ / ▼] to select "New Program", then press [OK].

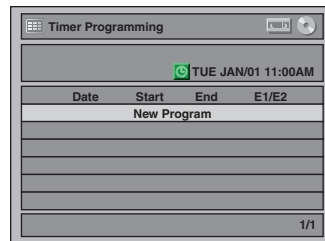

3 Use [▲ / ▼] to enter the date, then press [▶].

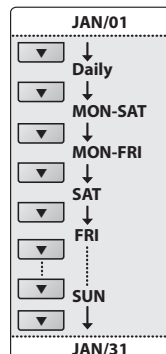
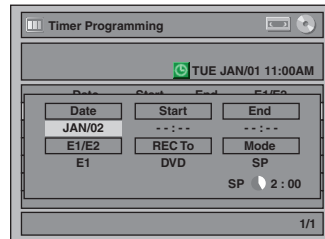

When pressing [▼] at the current date, the date will change as follows.

e.g.) January 1st

TIMER RECORDING

- 4** Use [▲ / ▼] or [the Number buttons] to enter the starting and ending time, then press [▶].

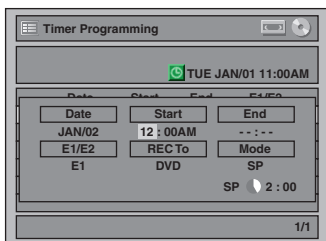

- 5** Use [▲ / ▼] to select the appropriate external input position (E1/E2) to which your external tuner is connected, then press [▶].

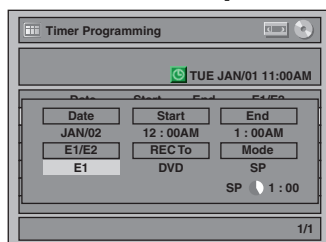

- 6** Use [▲ / ▼] to select a recording media ("DVD" or "VCR"), then press [▶].

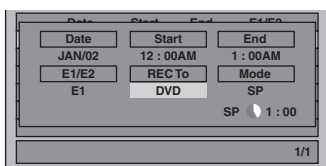

- 7** Use [▲ / ▼] to select a recording mode.

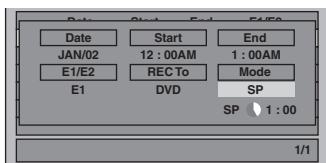

Refer to "Recording Mode" on page 24 for DVD or "Recording" on page 79 for VCR.

- You can check the remaining recordable space of the disc when you select the recording mode.



Auto recording mode select...(DVD only)

When "Auto" is selected as a recording mode, the unit calculates how much time is available on the disc and determines the appropriate recording mode to complete recording the program.



- "Auto" is only available for one program in the timer program list.
- The recording may be cut short when the available recording space of the disc is too limited.

- 8** Press [OK] when all items are entered.

Your program setting is now stored.

- To set another program, repeat steps 2 to 7.
- To exit, press [TIMER] or [SETUP].
- When 2 or more programs are overlapped, "Timer program overlapped" appears, and the overlapped program will be displayed in blue.
- To correct the timer program refer to "Checking, canceling, or correcting the timer programming information" on page 30.

- 9** Press [TIMER SET] to set a timer programming.

Ⓜ will appear on the front panel display.



"VCR" will appear if VCR timer recording have been set.

Note

- **If you have not set the clock yet:**
"Clock Setting" menu will appear instead of the timer programming list at step 1. Continue with the step 4 in "Clock Setting" on page 23 before setting a timer programming.
- Use [◀/▶] to move the cursor to the left and the right in "Timer Programming" menu.
- If a basic recording or one-touch timer recording is in progress on one component (e.g., VCR) and the timer recording set for the other component (e.g., DVD) is about to begin, the unit automatically switches to the programmed channel for timer recording 2 minutes before the programmed starting time, and the recording in progress (for VCR) will be canceled UNLESS their recording channels are the same. If their recording channels are the same, the timer recording will start without canceling the recording currently in progress. In this case, the recording of the same channel will be made on both DVD and VCR.
- Cancel the timer-standby mode by pressing [TIMER SET] before operation for either DVD or VCR. When finished operating, press [TIMER SET] to resume the timer-standby mode.
- In the timer-standby mode, you can turn on the power and use the component (VCR or DVD) which is not currently timer-programmed.

TIMER RECORDING

Checking, canceling, or correcting the timer programming information

- 1) Press [TIMER SET].
 will disappear on the front panel display.
- 2) Press [TIMER].
- 3) Check the information on the list you will need.

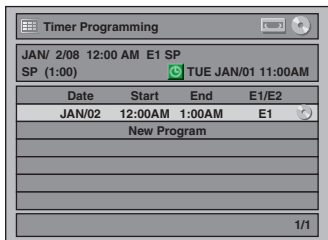

- 4-A) To delete the timer program:
 - 1 Use [▲ / ▼] to select the program you want to delete, then press [OK].
 - 2 Use [▲ / ▼] to select "Delete", then press [OK]. Confirmation window will appear.
 - 3 Use [▲ / ▼] to select "Yes", then press [OK].
- 4-B) To correct the timer program:
 - 1 Use [▲ / ▼] to select the program you want to correct, then press [OK].
 - 2 Use [▲ / ▼] to select "Program Change", then press [OK].
 - 3 Correct the timer program by using [▲ / ▼ / ◀ / ▶], then press [OK].
- 5) Press [TIMER] to exit.
- 6) Press [TIMER SET] to return to the timer standby mode.

To stop the timer recording in progress

Press [STOP ■] on the front panel to stop the disc recording.

Press [STOP ■/EJECT ▲] on the front panel to stop the cassette tape recording.

[STOP ■] on the remote control is not effective.

Note

- Press [TIMER] to check the timer recording in progress. When the timer recording is proceeding, that program will be highlighted with red. In this case, you cannot select any other program.

If the timer program did not complete correctly, the error number appears in the timer programming list.

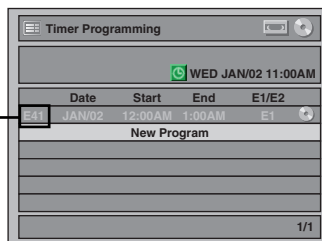



Each error number means:

E1-22 E37-39	Recording error other than below	E41	Power failed
E24	Unrecordable disc	E42	No disc when recording
E25-26	Copy prohibited program	E43	Already 49 titles recorded
E29	Disc protected	E44	Already 254 chapters recorded
E30	Disc full	E45	Copy prohibited program
E35	PCA full *1	E46	It is impossible to record additionally on a disc recorded by other units when setting "Make Recording Compatible" to "OFF".
E36	Already finalized video format disc		
E40	Some portion has not been recorded because of program overlapping. Recording did not start at the starting time.		

- E23, E27, E28, E31, E32, E33 and E34 are not displayed.
- A program with the error number is grayed in the timer programming list.
- Once the timer programming list with error line(s) is displayed, or after canceling and setting again the timer standby mode, the program line(s) with error will be cleared.

*1 PCA is a disc's space reserved for recording test.

Hints for Timer Recording

- If there is a power failure or this unit has been unplugged for more than 30 seconds, the clock setting and all timer programming will be lost.
- If a disc is not inserted, "DVD" on the front panel display flashes and timer recording cannot be performed. In some cases,  will appear momentarily around the start point as the unit attempts to record. Please insert a recordable disc.
- If a cassette tape with an erase-protection tab is not in the cassette compartment or there is no cassette tape in the cassette compartment, "VCR" on the front panel display flashes and timer recording cannot be performed. Please insert a recordable cassette tape.
- If you press **[TIMER SET]** and turn on the unit while either DVD or VCR is in timer standby mode,  disappears. In this case, you cannot change the mode between DVD and VCR. You cannot change any settings using **[SETUP]** or edit discs.
- When all the timer recording is completed,  flashes. To play back or eject the recorded disc, press **[TIMER SET]** first, then select the recorded title and press **[PLAY ►]**, or **[OPEN/CLOSE ▲]** to remove the disc.
- If both DVD and VCR are timer programmed, you cannot use any functions for either unit during timer standby or timer recording. If you want to use functions other than recording under such condition, cancel timer recording by pressing **[TIMER SET]** during timer standby or stop recording by pressing **[STOP ■]** on the front panel during timer recording.
- To cancel the timer standby mode, press **[TIMER SET]**.
- When the starting and the ending time are the same, the length of the recording will be set for 24 hours. When the disc or cassette tape becomes full during the recording, the unit turns itself off.
- When the programmed starting and ending time are earlier than the current time, the setting will not be accepted.
- If the starting time is earlier and the ending time is later than the current time, the recording will start right after you turn the power off.
- The timer recording cannot be performed in DVD and VCR at the same time. If you set 2 programming with the same channel and time in both devices, the program with a lower program number will be recorded.

The Priority of Overlapped Settings

- Timer program which has the earlier starting time will be placed first in the timer program list, and be given priority over the programs with the later starting time when timer programs overlap.
- When timer programs overlap, the first 2 minutes (at the longest) of the later recording will be cut off.
- When two or more timer programs have the same starting time, the program set first will be given priority.
- A timer recording of lower priority will be canceled or start from the middle.
- Check the overlapped timer programmings and change the priority if necessary.

■ When the starting time is the same:

A program set previously (PROG. A) has priority.

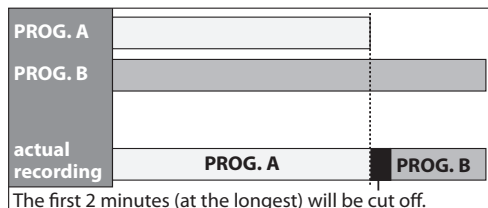

Note for DVD recording

- When the recording time of 2 programs are overlapped, or the ending time of a program and the starting time of another program is the same, the first 2 minutes (at the longest) of the subsequent program will be cut off.
- If the cut-off portion comes up to 3 minute or more, this program will be displayed with error number E40 in the timer programming list.

■ When the ending time of the programming currently being recorded and the starting time of the subsequent program are same:

The beginning of the PROG. B may be cut off.

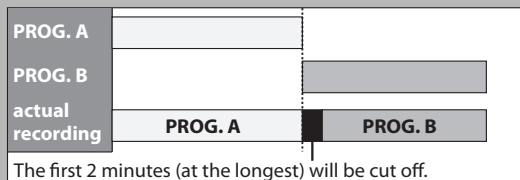

SATELLITE LINK

You can set the unit to start recording whenever it detects the video signal from the external tuner.

Preparing for the satellite link timer recording:

Preparation on the tuner

- Satellite link accepts only the connection from E1 (rear) with the external tuner. (The connection from E2 cannot read any signals from the external tuner.)
- The external tuner should be equipped with some kind of timer function. Using timer function of the tuner, set it to output audio/video signals when it comes to the time you want to start recording, and stop output audio/video signals when it comes to the time you want to finish recording. Refer to the tuner's manual on how to set the timer.
- Make sure to set the satellite link standby mode when you finish setting.



1 Press [SETUP].

2 Use [▲ / ▼] to select "Timer Programming", then press [OK].

3 Use [▲ / ▼] to select "Satellite Link", then press [OK].

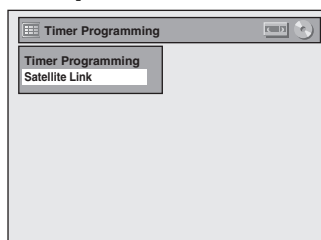

4 Use [▲ / ▼] to select the time, media and recording mode, then press [OK].

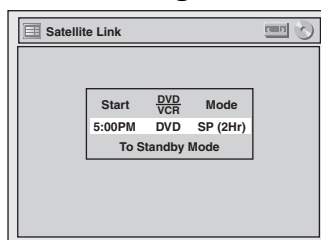

5 Use [▲ / ▼] to set the desired starting time, then press [▶].

- The hour can be selected from 1 to 12 with AM or PM.
- Repeat procedures in step 5 to set the desired minutes.
- If you wish to go back to the left, press [◀].

6 Use [▲ / ▼] to select a recording media ("DVD" or "VCR"), then press [▶].

7 Use [▲ / ▼] to select the recording mode. Refer to page 24 for details.

8

Press [OK].

"To Standby Mode" is highlighted.

9

Press [OK] again.

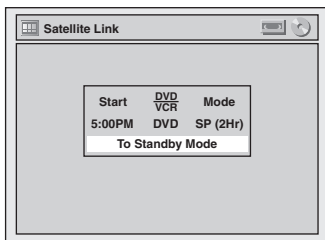

In a second, the unit will be turned off automatically as it goes into the satellite link standby mode.

To cancel the satellite link function while in the satellite link standby mode:

Press [TIMER SET] to turn on the unit.

To cancel the satellite link function while the satellite link recording is in progress:

Press [STOP ■] on the front panel to stop the disc recording.

Press [STOP ■/EJECT ▲] on the front panel to stop the cassette tape recording.

Notes

- If the signal of external input breaks up over 5 seconds, satellite link function will be canceled.
- If you have not set the clock, "Clock Setting" menu will appear at step 3. Follow to step 3 in "Clock Setting" on page 23.
- You cannot set the ending time for the satellite link timer recording on this unit.
- Recording picture will be distorted if the copy protection signal is being detected during satellite link timer recording.
- You can record the satellite link by using S-video input jacks on the rear panel. Refer to page 15 for more information.
- When a regular timer recording and the satellite link timer recording are overlapped, those recordings are recorded as illustrated below.
- Press [TIMER] during the satellite link timer recording to check the satellite link timer recording in progress.

	example 1	example 2	example 3
timer recording			
satellite link			
actual recording			

The first 2 minutes (at the longest) will be cut off.

The first 2 minutes (at the longest) will be cut off.

OVERWRITING UNNECESSARY TITLE

Overwriting from the Beginning of the Title



You can overwrite the existing title from the beginning.

- 1) Press **[STANDBY-ON ○]**.
Make sure that the TV input is set on the unit.
- 2) Load the disc that includes a title to be overwritten.

It takes a while to display the title list.

Title list will appear.
If the title list does not appear, press **[TITLE]**.

- 3) Press **[REC MODE]** to select a recording mode.
Refer to "Recording Mode" on page 24.
- 4) Use **[▲ / ▼]** to select a title to be overwritten, then press **[OK]**.

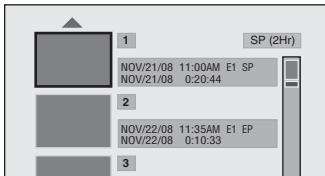

- 5) Use **[▲ / ▼]** to select "Overwrite", then press **[OK]**.

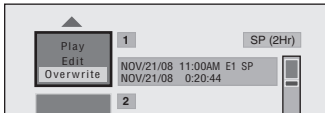

- 6) Press **[SOURCE]** to select the appropriate external input position (E1/E2) to which your external tuner is connected. Then select the desired channel to record on the external tuner.

e.g.) DVD+RW

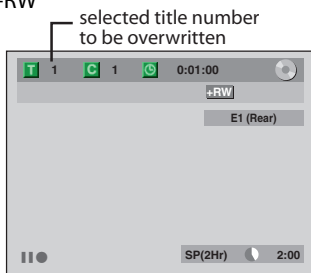

- 7) Press **[REC ●]**.
Overwriting recording starts.
The elapsed-time counter starts running.
- 8) Press **[STOP ■]** to stop recording.
Title name is also overwritten.

This operation may take a while to be completed.

Note

- The remaining recording time is displayed on the bottom right corner of the TV screen during overwriting.

Overwriting in the Middle of the Title



You can overwrite the existing title from the selected position.

- 1) Follow the steps 1, 2 and 4 on the left.
- 2) Use **[▲ / ▼]** to select "Play", then press **[OK]**.
Playback will start.
- 3) Press **[PAUSE II]** at the point from which you want to start overwriting.
- 4) Press **[REC ●]**.
"II●", display menu, channel, and the time lapse will be displayed as illustrated on the left.
- 5) Press **[SOURCE]** to select the appropriate external input position (E1/E2) to which your external tuner is connected. Then select the desired channel to record on the external tuner.
- 6) Press **[REC ●]** again.
Overwriting recording starts.
- 7) Press **[STOP ■]** to stop recording.

This operation may take a while to be completed.

Note

- Recording mode of the overwriting title is the same as that of the original (overwritten) title when overwriting in the middle of the title.
- Title name will not be overwritten.

OVERWRITING UNNECESSARY TITLE

Hints for Overwriting

When you overwrite on the unnecessary title, there were various circumstances as follows. Please note that following cases only describe the overwriting without any recording mode discrepancy. To avoid accidental deletion please check if there is no important title after the overwriting point.

- When overwriting title is shorter than the existing title:**
(overwriting from the beginning of the title)

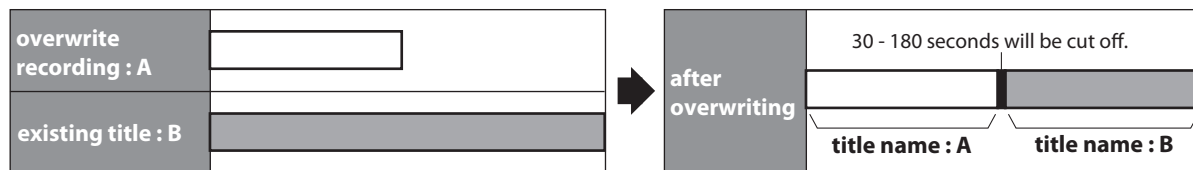

- When overwriting title is longer than the existing title:**
(overwriting from the beginning of the title)

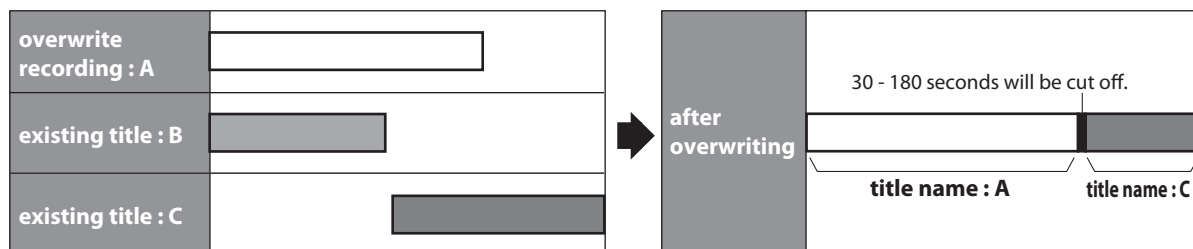
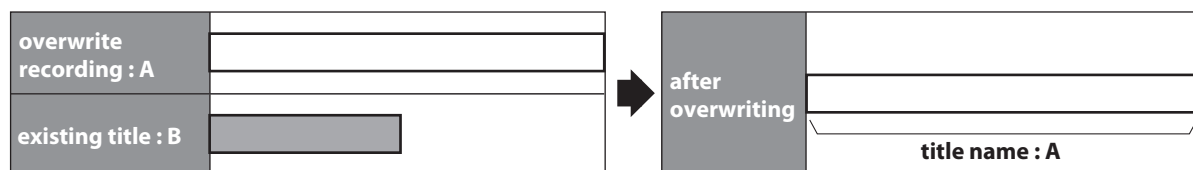

- When overwriting in the middle of the title:**

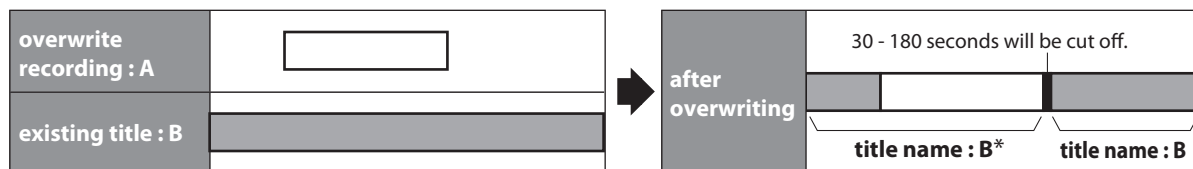

*Overwritten section and the rest of the sections will have the same title name as the original existing title (B).

Note

- When a title name is overwritten, its thumbnail is also overwritten.
- "Auto Chapter" interval time is reset at the overwriting start point.
- A chapter mark is put at the beginning of the overwrite title when overwriting in the middle of the title.



EXTERNAL DEVICE RECORDING

Recording from an External Device

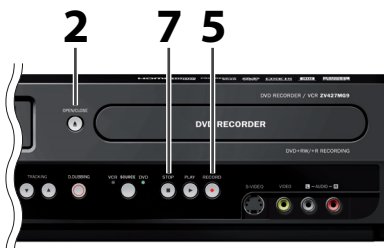
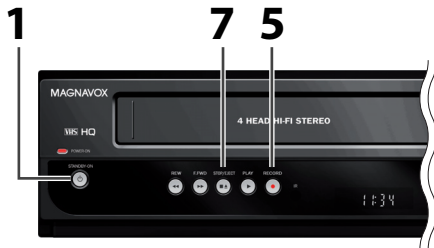
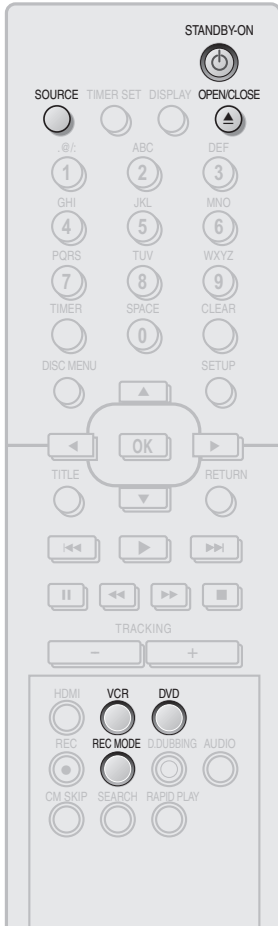
Before recording from an external device, refer to the instructions for the connection on page 14.



1 Turn on the TV and press [STANDBY-ON , and be sure to select the input of the TV to which the unit is connected.

2 When you want to record to the disc:
Press [DVD].
Press [OPEN/CLOSE ] to open the disc tray. Place the disc to record properly. Press [OPEN/CLOSE ] again to close the disc tray.

It takes a while to load the disc.

When you want to record to a cassette tape:
Press [VCR].

Insert the cassette tape with a erase-protection tab into the cassette compartment.

3 Select the input of the unit which the external device is connected. (E2 or E1)

- To use the input jacks on the rear of this unit; Select "E1 (Rear)" position by using [SOURCE].
- To use the input jacks on the front of this unit; Select "E2 (Front)" position by using [SOURCE].

4 Press [REC MODE] to select a recording mode.

Refer to "Recording Mode" on page 24 for DVD or "Recording" on page 79 for VCR.

5 Press [RECORD ] (DVD or VCR) on the unit to start recording.

6 Start playback on the external device to record from.

7 For disc:
Press [STOP ] on the unit to stop recording.

For cassette tape:

Press [STOP /EJECT ] on the unit to stop recording.

This operation may take a while to be completed.

SETTING A DISC TO PROTECT

To prevent accidental recording, editing or erasing the titles, you can protect them from “Disc Edit” menu.



1 Press [SETUP].

2 Use [▲ / ▼] to select “Disc Edit”, then press [OK].

3 Use [▲ / ▼] to select “Disc Protect OFF ➔ ON”, then press [OK].
e.g.) DVD+RW

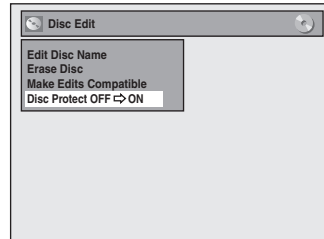

4 Use [▲ / ▼] to select “Yes”, then press [OK].

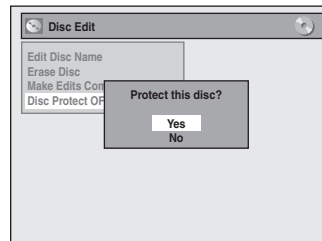

A disc will be protected.

This operation may take a while to be completed.

Note

To cancel the disc protect:

- When you insert a disc protected with this unit, “Disc Protect ON ➔ OFF” will appear instead of “OFF ➔ ON” at step 3.

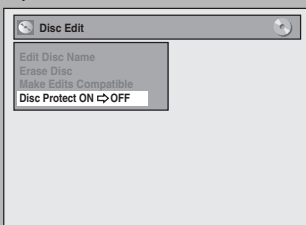

To release the protect for the disc, select “Disc Protect ON ➔ OFF” at step 3, then follow rest of the procedure.

PLAYING THE DISCS IN OTHER DVD PLAYERS

Finalizing a Disc



You will need to finalize discs to play back in other DVD players.

Finalizing may take from several minutes up to an hour.

A shorter recording period on the disc will require a longer time period for finalization. Do not unplug the power cord during finalization.

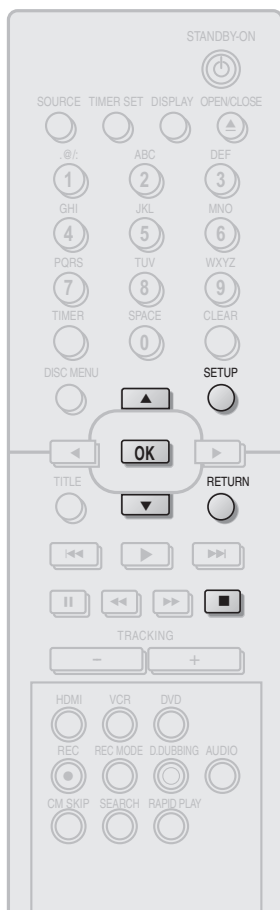

1 Press [SETUP].

2 Use [▲ / ▼] to select "Disc Edit", then press [OK].
"Disc Edit" menu will appear.

3 Use [▲ / ▼] to select "Finalize", then press [OK].

4 Use [▲ / ▼] to select "Yes", then press [OK].
e.g.) DVD+R, DVD-R

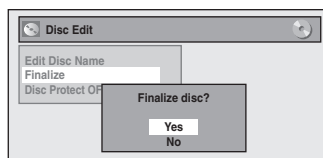

Finalizing will start.



To cancel finalizing... (DVD-RW only)

- To cancel finalizing at step 4, press [STOP ■], select "Yes" with [▲ / ▼], then press [OK]. Finalizing is canceled and the unit will be in stop mode.

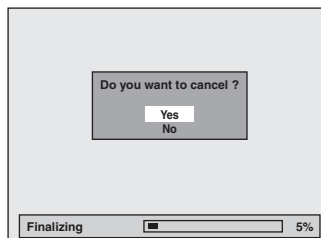

- If Ⓢ appears when pressing [STOP ■], you cannot cancel finalizing because the finalizing has been in certain progress.
- When selecting "No" and press [OK] or [RETURN], finalizing will be continued.
- You cannot cancel finalizing the DVD+R/DVD-R once it has started.

This operation may take a while to be completed.

5 Finalizing is completed.

Note

- Once you have finalized a DVD+R/ DVD-R, you cannot edit or record anything on that disc.
- There is no need to finalize DVD+RW.
- When you insert a DVD-RW finalized with this unit, "Undo Finalize" will appear instead of "Finalize".

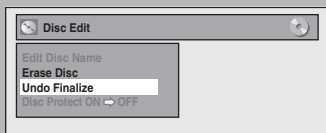

To release the finalizing for the disc, select "Undo Finalize" at step 3.

* DO NOT power off during finalization, otherwise this will result in malfunction.

PLAYING THE DISCS IN OTHER DVD PLAYERS

Auto Finalizing



You can finalize discs automatically using this function. You can use this function to finalize discs after finishing all timer recordings and at the end of the disc space.



1 Press [SETUP] and use [▲ / ▼] to select “General Setting”, then press [OK].

“General Setting” menu will appear.

2 Use [▲ / ▼] to select “Recording”, then press [OK].

“Recording” menu will appear.

3 Use [▲ / ▼] to select “Auto Finalize”, then press [OK].

4 Use [▲ / ▼] to select “Disc Full” or “End of Timer Rec”, then press [OK].

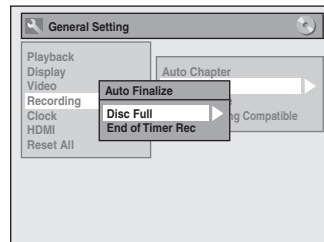

5 Use [▲ / ▼] to select “ON”, then press [OK].

e.g.) “Disc Full”

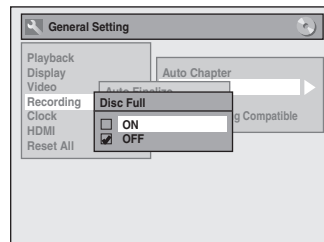

Your setting will be activated.

6 Press [SETUP] to exit.

DUBBING MODE



You can copy a DVD to a cassette tape or copy a cassette tape to a DVD. This function will be possible only if the DVD or the cassette tape is not copy protected.

Before starting this function, prepare for the recording on the DVD+RW/+R, DVD-RW/-R or the cassette tape. Refer to pages 24 and 79.

Make sure:

- Insert a recordable disc and a cassette tape with a erase-protection tab.

Note for recording to a cassette tape:

- The cassette tape's erase-protection tab is intact.
- The remaining time of the cassette tape is long enough.

Note for recording to a disc:

- Make sure that the disc is recordable. Refer to page 24.

1 Press [SETUP] and use [▲ / ▼] to select "General Setting", then press [OK].

"General Setting" menu will appear.

2 Use [▲ / ▼] to select "Recording", then press [OK].

"Recording" menu will appear.

3 Use [▲ / ▼] to select "Dubbing Mode", then press [OK].

Selection menu will appear.



Note for VCR to DVD duplication

- After starting VCR to DVD duplication, the picture may be distorted because of the auto tracking function.

This is not a malfunction. Be advised to playback the cassette tape until the picture is stabilized, then set the starting point which you wish to start recording, and start VCR to DVD duplication.

DUBBING MODE

VCR to DVD

DVD to VCR

4 Use [▲ / ▼] to select “VCR → DVD”, then press [OK].

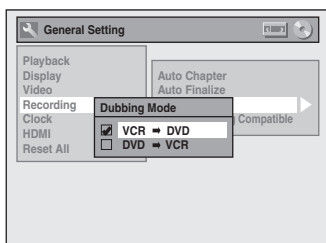

4 Use [▲ / ▼] to select “DVD → VCR”, then press [OK].

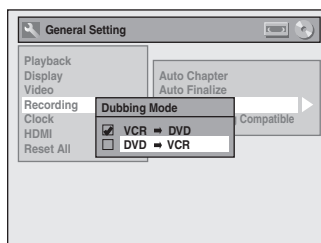

5 Press [SETUP] to exit.
Press [VCR].

5 Press [SETUP] to exit.
Press [DVD].

6 Press [PLAY ►]. Then press [PAUSE ■] at the point you wish to start recording.

- Since it takes about a few seconds before the actual dubbing begins, please allow extra 5 seconds when selecting the starting point.

6 Press [PLAY ►]. Then press [PAUSE ■] at the point you wish to start recording.

7 Press [DVD].
Make sure to select a recording mode using [REC MODE].

7 Press [VCR].
Make sure to select a recording mode using [REC MODE].

8 Press [D.DUBBING].
VCR to DVD duplication will start.

8 Press [D.DUBBING].
DVD to VCR duplication will start.

9 Press [STOP ■] to stop the recording.
Title list will automatically appear.

- If you want to watch the duplicated material after the VCR to DVD duplication, press [OK] and then select “Play” in the title.

9 Press [STOP ■] to stop the recording.

Note

- When you turn off the unit after setting the dubbing mode to **DVD → VCR**, the setting will be set to **VCR → DVD** automatically.
- You cannot change the output mode during VCR to DVD or DVD to VCR duplication.

For Audio CD to VCR duplication:

- This function is available on Audio CD, not MP3 files.

For VCR to DVD duplication:

- The playback sound mode is followed by the setting of VCR playback sound mode on page 80. Set the playback sound mode to which you wish to record to the DVD.
- This unit will automatically stop the duplication if playback with no image is for more than 3 minutes during VCR to DVD duplication.
- Dubbing indicator will appear on the front panel display during dubbing.

INFORMATION ON PLAYBACK

Before you play back DVD, read the following information.

Playable Discs and Files

This unit is compatible to play back the following discs. To play back a DVD, make sure that it meets the requirements for region codes and color systems as described below. You can play back discs that have the following logos will play back on the unit. Other disc types are not guaranteed to play back.

Playable discs	Logos
DVD-video	
DVD+RW	
DVD+R	
DVD-RW (Finalized video mode discs only)	
DVD-R (Finalized video mode discs only)	
CD-DA (audio CD)	
video CD	
CD-RW	
CD-R	
Playable files	Media
CD-DA	CD-RW/-R
MP3	

is a trademark of DVD Format/Logo Licensing Corporation.

Unplayable Discs

The following discs will not play back on this unit.

- CD-ROM
- DVD-RAM
- DVD-ROM
- Unfinalized disc
- DVD contains MP3 and DVD or CD contains Windows Media™ Audio/JPEG files
- DVD-R or DVD-RW recorded in VR mode or non compatible recording format
- Blu-ray Disc
- Compact Disc-Interactive (CD-I)
- Video Single Disc (VSD)
- DVD-audio
- HD DVD

On the following disc, the sound may not be heard.

- Super audio CD - Only the sound on the CD layer can be heard. The sound on the high-density super audio CD layer cannot be heard.

Color Systems

DVD is recorded in different color systems throughout the world. The most common color system is NTSC (which is used primarily in the United States and Canada). This unit uses NTSC, so DVD you play back must be recorded in the NTSC system. You cannot play back DVD recorded in other color systems.

Region Codes

This unit has been designed to play back DVD with region 1. DVD must be labeled for ALL regions or for region 1 in order to play back on the unit. You cannot play back DVD that are labeled for other regions. Look for the symbols on the right on your DVD. If these region symbols do not appear on your DVD, you cannot play back the DVD in this unit.



The number inside the globe refers to region of the world. A DVD labeled for a specific region can only play back on the unit with the same region code.

PBC (playback control) for Video CD

You can select images or information on the menu screen by activating the PBC (playback control) function of the video CD. This unit conforms to ver.1.1 and ver. 2.0 of video CD standard with PBC function.

Ver.1.1 (without PBC function): You can enjoy playback picture as well as music CD.

Ver.2.0 (with PBC function): While using a video CD with PBC function, "PBC" appears on the TV screen.

Note

- PBC setting turns to "ON" when loading video CD with PBC function, thus, even after setting PBC to "OFF" and ejecting the video CD then reloading the video CD, this setting turns to "ON" automatically.
- Some operations cannot be performed while PBC function is on. Cancel PBC function temporarily to perform those operations by following the instruction below.

1) Press [SETUP].

2) Use [▲ / ▼] to select "CD Playback Mode", then press [OK]. "CD Playback Mode" menu will appear.

3) Use [▲ / ▼] to select "PBC (Video CD only)", then press [OK].

4) Use [▲ / ▼] to select "ON" or "OFF", then press [OK]. Your setting will be activated.

You can play back interactive software using menu screens. Refer to instructions in the video CD.

Hint for DVD Playback

The contents of DVD are generally divided into titles. Titles may be further subdivided into chapters.

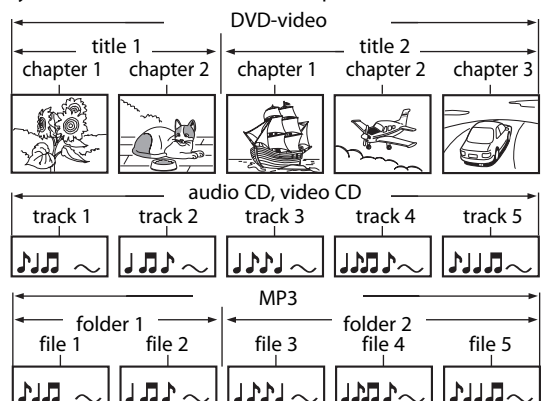

BASIC PLAYBACK

Direct Playback

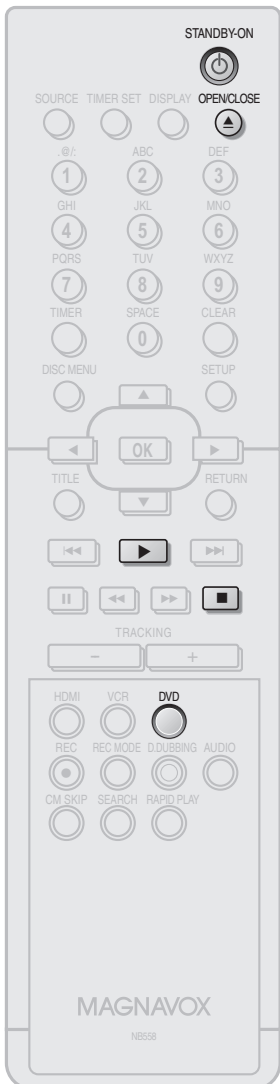

1 Press [STANDBY-ON ].
Turn on the TV and be sure to select the input to which the unit is connected.
Press [DVD].

2 Press [OPEN/CLOSE ] to open the disc tray and insert your disc with its label facing up.

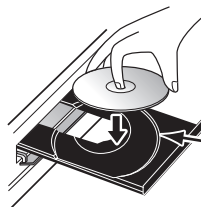



Align the disc to the disc tray guide.

* Make sure the disc is compatible with this unit.
(Refer to page 42 for the list of compatible discs.)

3 Press [OPEN/CLOSE ] to close the disc tray.

It may take a while to load the disc completely.

4 Press [PLAY ] to start playback.
If you are playing back a DVD-video or video CD with PBC function, a menu may appear.
Refer to "Using the Title / Disc Menu" on page 47.

5 Press [STOP ] once to stop playback temporarily.
• Refer to "Resume Playback" on page 48.

Note

- Some discs may start playback automatically.
- You can select images or information on the menu screen by activating PBC (playback control) function (page 42).

BASIC PLAYBACK

Playback from the Title List



1 Press [STANDBY-ON ].
Turn on the TV and be sure to select the input to which the unit is connected.

Press [DVD].

2 Press [OPEN/CLOSE ] to open the disc tray and insert your disc with its label facing up.

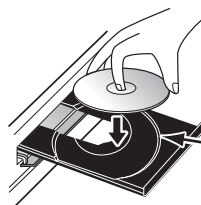

Align the disc to the disc tray guide.

* Make sure the disc is compatible with this unit.
(Refer to page 42 for the list of compatible discs.)



3 Press [OPEN/CLOSE ] to close the disc tray.

It may take a while to load the disc completely.

- To exit the title list, press [STOP ].
- To resume the title list, press [TITLE].

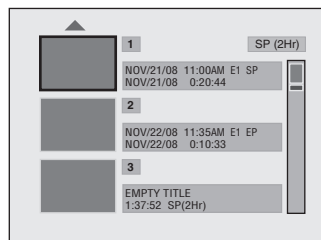
4 Use [ / ] to select a desired title, then press [OK].



- For Video CD, when “PBC (Video CD only)” in “CD playback Mode” menu is set to “ON”, the video CD main menu will appear when inserting a disc. In such a case, select a numbered menu with [the Number buttons].
- Press [] to display the next page, and press [] to display the previous page.

Note

- You can also start playback by pressing [PLAY ] instead of [OK] at step 4.

5 Use [▲ / ▼] to select "Play", then press [OK].

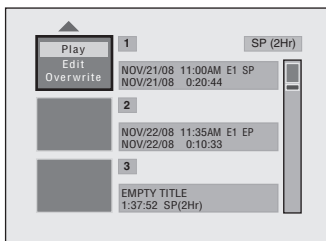

Playback will start.

6 Press [STOP ■] once to stop playback temporarily.

- Refer to "Resume Playback" on page 48.
- To eject the disc, press [OPEN/CLOSE ▲] to open the disc tray, then remove the disc before turning off the unit.

If you want to see disc information, press [◀] when the first page of the title list is displayed or press [▲] when the first title is selected but not when "Play", "Edit" or "Overwrite" is highlighted.

e.g.) DVD+RW

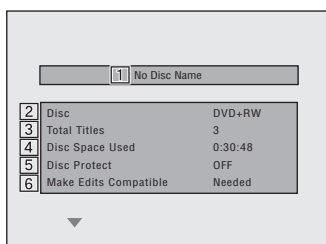

e.g.) DVD+R

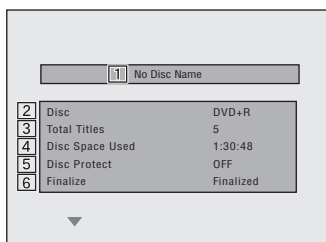

1. Disc name
(Default "No Disc Name")
2. Disc type
(DVD+RW/DVD+R/ DVD-RW/DVD-R)
3. Total number of title
(include "EMPTY TITLE")
4. Total time of recorded disc space
5. Status of disc protection
(“ON” is protected disc.)
6. Making edits compatible/finalize
 - When DVD+RW is inserted:
If the disc needs to be set "Make Edits Compatible", "Needed" is displayed. Otherwise, "Not Needed" is displayed. (Refer to page 69.)
 - When DVD+R, DVD-RW or DVD-R is inserted:
If "Finalize" is done, "Finalized" is displayed. Otherwise, "Unfinalized" is displayed.

BASIC PLAYBACK

Playing Back an Audio CD and a CD-RW/-R with MP3 Files



1 Follow steps 1 to 2 in “Direct Playback” on page 43.

2 Press [OPEN/CLOSE ▲] to close the disc tray.

It may take a while to load the disc completely.

When an audio CD is inserted, track list will appear.

When a CD-RW/-R with MP3 files is inserted, file list will appear.

- To exit the track/file list, press [STOP ■].
- To resume the track/file list, press [TITLE].

3 Use [▲ / ▼] to select a desired folder or track/file, then press [OK].
e.g.) File list

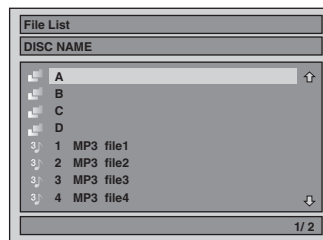

When selecting track/file:

Playback will start.



When selecting the folder (Not available for audio CD):

The files in the folder will appear.

Use [▲ / ▼] to select the file or folder you want to play back, then press [OK].

- Press [PLAY ▶], [OK] or [▶] to move to any lower hierarchies.
- Press [◀] or [RETURN] to move back to the previous hierarchy.

Hints for audio CD tracks and MP3 files:

- Folders are shown by .
- Audio CD tracks are shown by .
- MP3 files are shown by .
- The system can recognize up to 255 folders, up to 99 tracks/999 files.
- Letters of a file/folder name overflowing the given space will be displayed as "...". Unrecognizable characters will be replaced with asterisks.
- If there are no files in the folder, "No Files" will be displayed.

It is recommended that files to be played back in this unit are recorded under the following specifications:

<MP3>

- Sampling frequency : 44.1 kHz or 48 kHz.
- Constant bit rate : 112 kbps - 320 kbps

Note

- The audio source of MP3 files cannot be recorded as digital sound by an MD or DAT deck.
- Files whose extension is other than ".mp3(MP3)" will not be listed.
- Some unplayable folders or files may be listed due to the recording status.

BASIC PLAYBACK

Using the Title / Disc Menu



DVD or video CD with PBC function may contain a title list, which describes the contents of the disc, or a disc menu, which guides you through the available functions in the disc.

Press [DVD] first.

1) Press [TITLE] or [DISC MENU] to call up the title list or disc menu.

2) Use [▲ / ▼ / ◀ / ▶] to make a selection, and then press [OK] to enable your selection.

3) Press [STOP ■] to exit.

Note

- You can select a numbered menu with [the Number buttons] also.
- Menus vary among discs. Refer to the information accompanying the disc for details.
- [TITLE] or [DISC MENU] will not always be active with all DVD.
- For video CD, when "PBC (Video CD only)" in "CD Playback Mode" menu is "ON", the video CD main menu will appear when inserting a disc.

Pause

Press [DVD] first.

1) During playback, press [PAUSE II].

Playback will be paused and sound will be muted.

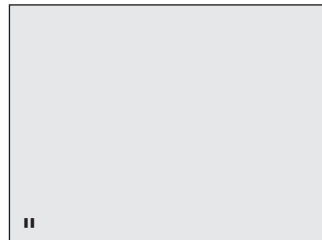

2) Press [PLAY ▶] to return to the normal playback.

Note

- On DVD, set "Still Mode" to "Field" in "Playback" menu if pictures in the pause mode are blurred. (Refer to page 74.)

SPECIAL PLAYBACK

Resume Playback

You can play back from where you stopped playing back the disc last.

Press [DVD] first.

1) During playback, press [STOP ■].

The resume message will appear.

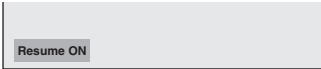

2) Press [PLAY ►].

In a few seconds, playback will resume from the point at which it stopped last. You can resume playback at the same point even if you turn off the unit.

To cancel the resume playback and start playing back the disc from the beginning, press [STOP ■] again while the playback is stopped.

Note

- For MP3 files, playback will resume from the beginning of the file at which playback was stopped.
- Some video CD with the PBC function resume playback from the beginning of the track.

Fast Forward / Fast Reverse Playback



Press [DVD] first.

1) During playback, press [►►] or [◄◄].

Every time you press [►►] or [◄◄], approximate speed will be changed as follows.

Fast forward or fast reverse playback across titles (for DVD) or files (for MP3 files) is not possible.



For video CD, approximate forward/reverse speeds are 2x, 8x, 16x.

For audio CD, MP3 files, approximate speed is fixed at 8x with sound (indicated with ►►►► / ►◄◄◄).

2) Press [PLAY ►] to return to the normal playback.

Note

- Forward/reverse speed will be indicated with icons as follows.

forward (approx. speed)

- 2x: ►►
- 20x: ►►►
- 40x: ►►►►

reverse (approx. speed)

- 5x: ►◄
- 20x: ►◄◄
- 40x: ►◄◄◄

Skipping TV Commercials During Playback



You can skip TV commercials to enjoy the recorded programs without interrupting.

Press [DVD] first.

During playback, press [CM SKIP].

Normal playback will start at 30 seconds ahead from the point you press [CM SKIP].

Every time you press [CM SKIP], the searching point will be extended by 30 seconds ahead.

You can press [CM SKIP] up to 6 times (180 seconds).

e.g.) Press [CM SKIP] once.

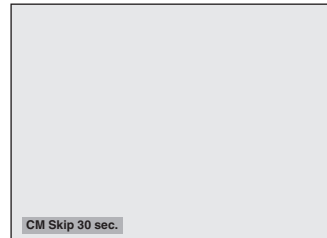

(forwarding 30 seconds)

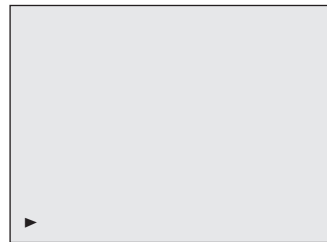

Playback will return to the normal playback.

SPECIAL PLAYBACK

Rapid Playback



Rapid playback function is available only during playback.

This function is available only on discs recorded in the Dolby Digital format, and plays back in a slightly faster/slower speed while keeping the sound output.

Press [DVD] first.

1) During playback, press [RAPID PLAY].

- ▶ : Press [RAPID PLAY] once during playback. Plays back approximately at 0.8 times of normal playback.
- ▶ : Press [RAPID PLAY] twice during playback. Plays back approximately at 1.3 times of normal playback.
- ▶ : Press [RAPID PLAY] 3 times to play back in normal speed. No effects.

2) Press [PLAY ►] to continue the normal playback.

Note

- Audio (language) setting cannot be changed while using this mode.
- This feature may not work at some point in a disc.
- When using digital audio connection (COAXIAL), the LPCM sound (2 channel) will be output.

Step by Step Playback



Press [DVD] first.

1) During playback, press [PAUSE III].

Playback will be paused and sound will be muted.

2) Press [NEXT ►►] repeatedly.

Playback will advance one frame (or step) at a time when you press [NEXT ►►] with the sound muted.

To play back step by step backward:

Press [PREV ◄◄] repeatedly.

Every time you press the button, the playback will go backward by one frame.

- Press and hold [PREV ◄◄] / [NEXT ►►] to reverse/advance continuously.

3) Press [PLAY ►] to continue the normal playback.

Note

- Only step by step forward playback is available for playing back video CD.

Slow Forward / Slow Reverse Playback



Press [DVD] first.

1) During playback, press [PAUSE III]. Then press [►►] or [◄◄].

Every time you press [►►] or [◄◄], approximate speed will be changed as follows. (The sound will remain muted.)



2) To return to the normal playback, press [PLAY ►].

Note

- Forward/reverse speed will be indicated with icons as follows.
forward (approx. speed)
1/16x:
1/8x:
1/3x:
reverse (approx. speed)
1/16x:
1/8x:
1/4x:
- Only slow forward is available when playing back video CD.

SPECIAL PLAYBACK

Zoom



Press [DVD] first.

1) During playback, press [DISPLAY].

2) Use [◀/▶] to select , then press [OK] within 1 second or wait for 1 second to display the selection menu.

e.g.) DVD-video

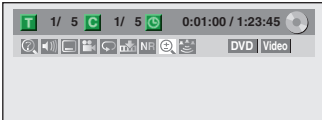

3) Use [▲/▼] to select a desired zoom factor to zoom, then press [OK].

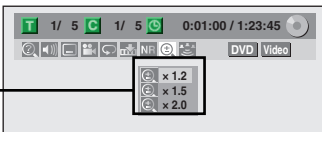

Zoom menu will appear.

There are four options

(x1.0, x1.2, x1.5 and x2.0), these are displayed excluding the current zoom rate.

Zoom area will be displayed.

4) Use [▲/▼/◀/▶] to select a desired zoom position, then press [OK].

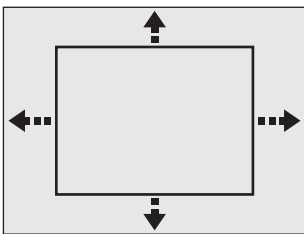

Zoom playback will start.

Note

- When selecting a smaller factor than the current one, the zoom area will not be displayed.
- To exit the zoom menu, press [DISPLAY] again at step 1.
- To cancel the zoom function, select "x1.0" using [▲/▼], then press [OK].

Marker Setting



This feature allows you to assign a specific point on a disc to be called back later.

Press [DVD] first.

1) During playback, press [DISPLAY].

2) Use [◀/▶] to select , then press [OK] within 1 second or wait for 1 second to display the marker list.

e.g.) DVD-video

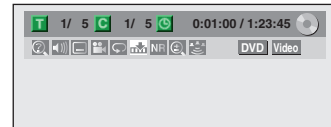

3) Use [▲/▼] to select a desired marker number. When it reaches the desired point, press [OK].

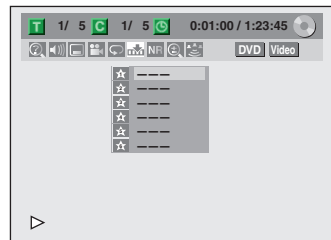

The title (track) number and the time will be displayed.

4) To return to the marker later:

Use [▲/▼] to select the desired marker number, then press [OK].

Note

- To clear a marker, select the marker number to be cleared, then press [CLEAR].
- All markers will be erased when you operate these operations listed below.
 - Opening the disc tray
 - Turning off the power
 - Record on a recordable disc
- You can mark up to 6 points.
- Marker setting is not available when you play back the video CD with PBC function.

Title / Chapter Search



Using [PREV ◀◀] / [NEXT ▶▶]

Press [DVD] first.

- 1) During playback, press [NEXT ▶▶] to skip the current title or chapter and move to the next.
The title or chapter will move forward by one at a time.
 - If there is no chapter in one title, the current title will be skipped.

To go back to the beginning of the current title or chapter, press [PREV ◀◀].

Press it repeatedly to go to the previous title or chapter. The title or chapter will move backward one at a time.

Using [DISPLAY]

Press [DVD] first.

- 1) During playback, press [DISPLAY].
- 2) Use [◀/▶] to select , then press [OK].
e.g.) DVD-video

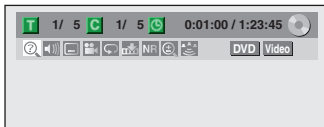

The number next to **T** will be highlighted.

3) Title:

Use [▲ / ▼] or [the Number buttons] to enter a desired title number to search, then press [OK].
Title search will start.

Chapter:

Press [▶] to move to the number next to **C** for chapter.

Use [▲ / ▼] or [the Number buttons] to enter a desired chapter number to search, then press [OK].
After the search, playback will start automatically.

Note

- In search mode display, total numbers of each search contents (title/chapter/time) are shown as a denominator.

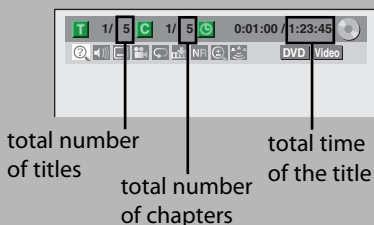

Track Search



Using [PREV ◀◀] / [NEXT ▶▶]

Press [DVD] first.

- 1) During playback, press [NEXT ▶▶] to skip the current track/file and move to the next.
The track/file will move forward one at a time.
To go back to the beginning of the current track/file, press [PREV ◀◀].
Press it repeatedly to go to the previous track/file. The track/file will move backward one at a time.

Using [DISPLAY]

Press [DVD] first.

- 1) During playback, press [DISPLAY].
- 2) Use [◀/▶] to select , then press [OK].
e.g.) audio CD

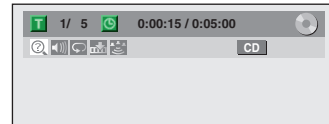

e.g.) MP3 files

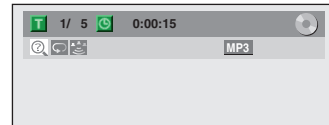

The number next to **T** will be highlighted.

- 3) Use [▲ / ▼] or [the Number buttons] to enter a desired track/file number to search, then press [OK].
After the search, playback will start automatically.

Note

- During CD playback you can enter a track number directly using [the Number buttons] for track search without displaying the menu.
- Track search is not available when you play back the video CD with PBC function.

Time Search



Press [DVD] first.

1) During playback, press [DISPLAY].

2) Use [◀/▶] to select , then press [OK].

e.g.) DVD-video

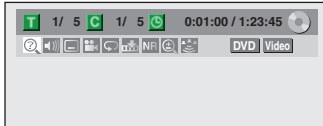

e.g.) audio CD

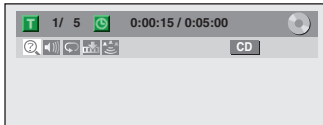

The number next to  will be highlighted.

To move to the number next to , press [▶].

When time search is not available,  and time counter are not displayed.

3) Use [▲ / ▼ / ◀ / ▶] or [the Number buttons] to enter a desired time to search, then press [OK].

After the search, playback will start automatically.

Note

- Time search is available only in the same track, file or title.
- Time search is not available when you play back the video CD with PBC function.

Repeat Playback

Available repeat function may vary depending on the discs.

Press [DVD] first.

1) During playback press [DISPLAY].

2) Use [◀/▶] to select , then press [OK] within 1 second or wait for 1 second to display the selection menu.

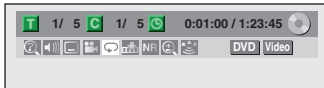

3) Use [▲/▼] to select a desired option to repeat, then press [OK].

e.g.) DVD-video

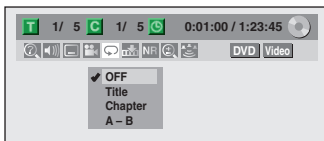

e.g.) audio CD, video CD

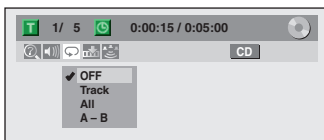

e.g.) MP3 files

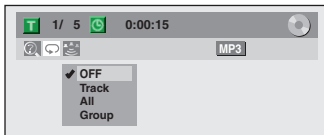

The selected repeat playback will start.

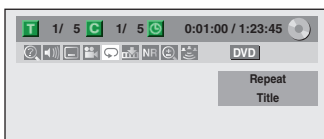

Title:

The current title will be played back repeatedly.

Chapter:

The current chapter will be played back repeatedly.

All:

The current disc will be played back repeatedly.

A-B:

Desired section can be played back repeatedly.

- 1) Use [▲/▼] to select "A-B", then press [OK].
- 2) Press [OK] at the desired starting point A.
- 3) Press [OK] at the desired ending point B.

Track:

The current track or file will be played back repeatedly.

Group:

The current folder will be played back repeatedly.

Note

- Point B for the repeat A-B playback should be set within the same title or track as point A.
- To cancel the repeat playback, select "OFF" at step 3. The repeat setting will also be canceled when you stop playback.
- You cannot select "Group" during the random playback of MP3 files.
- Repeat playback is not available when you play back the video CD with PBC function.

Random Playback



You can play back a disc randomly instead of playing back in the original order.

Press [DVD] first.

1) Press [SETUP].

2) Use [▲/▼] to select "CD Playback Mode", then press [OK].

"CD Playback Mode" menu will appear.

3) Use [▲/▼] to select "Random Play", then press [OK].

Random playback will start.

Note

- To cancel random playback, press [STOP ■] twice during random playback. "OFF" appears on the TV screen.
- For video CD with PBC function, the PBC setting will be switched to off automatically when you start random playback.

Program Playback



You can program the disc to play back in your desired order.

Press [DVD] first.

1) Press [SETUP].

2) Use [▲ / ▼] to select "CD Playback Mode", then press [OK].

"CD Playback Mode" menu will appear.

3) Use [▲ / ▼] to select "Program Play", then press [OK].

4) Use [▲ / ▼] to select a desired track, then press [OK] or [▶].

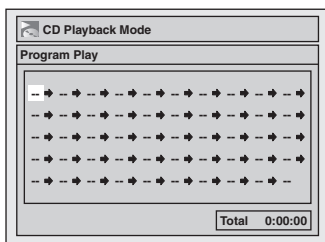

Repeat this step until you program all the desired tracks.

5) Press [PLAY ▶].

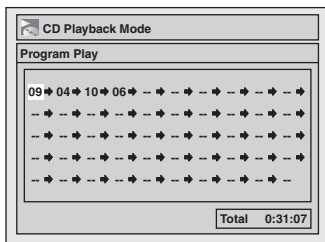

Program playback will start.

Note

- To erase tracks you selected, press **[CLEAR]** at step 4.
- You can make program settings up to 50 tracks.
- To cancel program playback, press **[STOP ■]** twice during program playback. "OFF" appears on the TV screen.
- You may also select a desired track using **[the Number buttons]** at step 4.
- For video CD with PBC function, the PBC setting will be switched to off automatically when you start program playback.

SPECIAL SETTING

You can select the format of audio and video as you prefer depending on the contents of the disc you are playing back.

Switching Subtitles



DVD-video may have subtitles in 1 or more languages. Available subtitle languages can be found on the disc case. You can switch subtitle languages anytime during playback.

Press [DVD] first.

1) During playback, press [DISPLAY].

2) Use [◀/▶] to select , then press [OK] within 1 second or wait for 1 second to display the selection menu.

e.g.) DVD-video

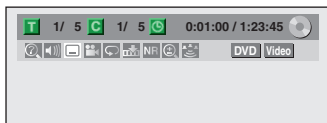

3) Use [▲/▼] to select a desired subtitle language, then press [OK].

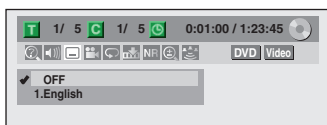

Subtitle will be displayed in the selected language. When selecting "OFF", subtitle will disappear.

Note

- Some discs will only allow you to change the subtitle from the disc menu. Press [TITLE] or [DISC MENU] to display the disc menu.
- If a 4-digit language code appears in the subtitle menu, refer to the "LANGUAGE CODE" on page 85.

Switching Audio Soundtrack



When playing back a DVD-video recorded with 2 or more soundtracks (these are often in different languages), you can switch them during playback.

When playing back video CD, audio CD you can switch "L/R"(stereo), "L"(left) or "R"(right).

Press [DVD] first.

1) During playback, press [DISPLAY] or [AUDIO].

- If you press [AUDIO], skip to step3.

2) Use [◀/▶] to select , then press [OK] within 1 second or wait for 1 second to display the selection menu.

3) Use [▲/▼] to select a desired audio soundtrack or audio channel, then press [OK].

For DVD-video

- Audio soundtrack will switch.

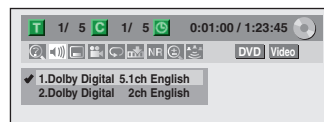

- If the title contains both main and sub audio, you can further select "L" (main), "R" (sub), or "L/R" (mixed of main and sub).

For audio CD, video CD

- Audio channel will switch.

e.g.) audio CD

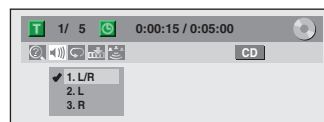

Note

- Some discs will only allow you to change the soundtrack from the disc menu. Press [TITLE] or [DISC MENU] to display the disc menu.

SPECIAL SETTING

Switching Virtual Surround System



You can enjoy stereophonic virtual space through your existing 2 channel stereo system.

Press [DVD] first.

1) During playback, press [DISPLAY].

2) Use [◀/▶] to select , then press [OK] within 1 second or wait for 1 second to display the selection menu.

e.g.) DVD-video

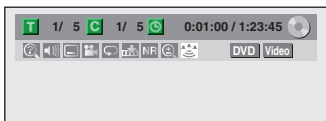

3) Use [▲/▼] to select "OFF", "Type 1" or "Type 2", then press [OK].

e.g.) DVD-video



OFF : no effect

Type 1 : natural effect

Type 2 : emphasized effect

Note

- Select "OFF" in a case sound is distorted.
- The setting will be kept even when the unit is turned off.

Switching Camera Angles



Some DVD-video have scenes shot from 2 or more angles. Angle information should be on the disc case if the disc contains multi-angle scenes.

Press [DVD] first.

1) During playback, press [DISPLAY].

2) Use [◀/▶] to select , then press [OK].
e.g.) DVD-video

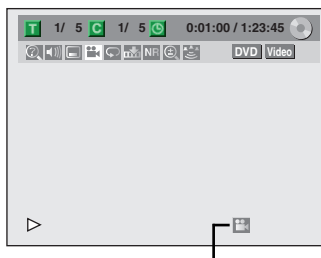

Angle icon appears when a switching camera angle is available.

Angle will switch each time you press [OK].

Note

- Angle icon does not appear on the TV screen in a case you set "Angle Icon" to "OFF" in "Playback" menu. Refer to page 74.

Reducing Block Noise



Press [DVD] first.

1) During playback, press [DISPLAY].

2) Use [◀/▶] to select **NR**, then press [OK] within 1 second or wait for 1 second to display the selection menu.

e.g.) DVD-video

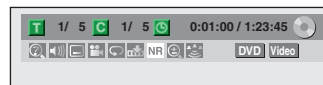

3) Use [▲/▼] to select a desired option, then press [OK].



Your setting will be activated.

This function reduces noise in the playback picture. If noises appear on the TV screen during playing back discs recorded in long time recording mode such as EP or SLP, select "Type 1" or "Type 2". ("Type 2" is more effective.)

When playing back discs with a few noises such as DVD-video, select "OFF".

Guide to a Title List

Title list allows you to check the titles recorded on the disc easily. You can choose a title to play back from this list and easily edit the titles as you prefer.

Press [TITLE].

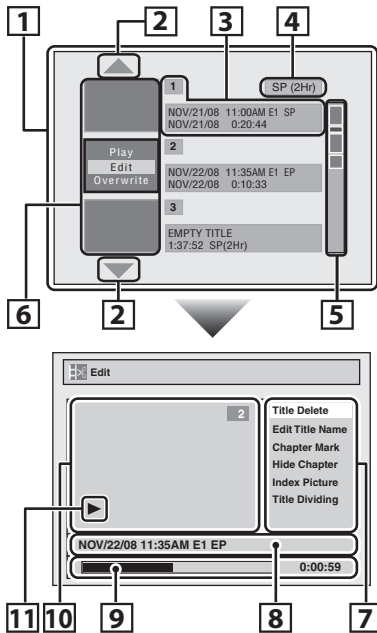

1. **Title list:** List of the titles recorded on the disc, and their information.
2. **Arrow:** Indicating there is a previous / next page.
3. **Title information:** On the first line, title name (editable) is displayed. On the second line, the length of the title is displayed.
Empty title: The portion of the disc where there is no recordings are made. As for the empty title, available recording time by the selected recording mode is displayed on the second line.
4. **Recording mode:** Currently selected recording mode is displayed here.
5. **Capacity indicator:** Indicating the position and the amount of each title in the disc. The portion for the selected title is highlighted.
6. **Thumbnails:** A cut from the recorded content is displayed here.
7. **Submenu:** Submenus for the selected menu are displayed here.
8. **Title name (editable):** If you do not name the title, the recorded date, time, selected external input position, and the recording mode are displayed here.
9. **Progress bar:** Indicating the progress of the playback.
10. **Preview window:** Preview of the selected title is displayed here.
11. **Playback status:** Indicating the current playback status of the selected title.

Press [STOP ■] to exit the title list.

Editing Discs

You can edit discs for the following items. Be sure that once you edit titles, they will not remain as original.

- Deleting Titles (Refer to page 58.)
- Putting Names on Titles (Refer to page 59.)
- Setting Chapter Marks (Refer to page 60.)
- Clearing Chapter Marks (Refer to pages 61-62.)
- Hiding Chapters (Refer to page 63.)
- Setting Pictures for Thumbnails (Refer to page 64.)
- Dividing a Title (DVD+RW/DVD-RW only) (Refer to page 65.)
- Putting Name on Disc (Refer to page 66.)
- Setting or Releasing Disc Protect (Refer to page 67.)
- Erasing Disc (Refer to page 68.)
- Making Edits Compatible (Refer to page 69.)

Note

- When selecting "Edit" on pop-up menu of the title list and edit the title, the title list is displayed after writing the edited contents onto the disc.
- The capacity indicator in the right side of the title list may not indicate the precise capacity in the disc.
- The capacity indicator may not indicate the capacity for the titles of which recording time is short.
- Once you have finalized a DVD+R/DVD-R, you cannot edit or record anything on that disc.

EDITING DISCS

Deleting Titles

You can delete titles which you do not need anymore. Please be advised that the titles once deleted cannot be brought back to the disc.

For DVD+RW/DVD-RW, when the last recorded title in the title list is deleted, the available disc space to record on will be increased. For DVD+R/DVD-R, the disc space to record on will not be changed.

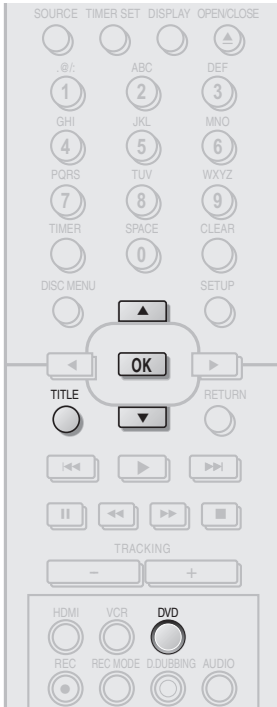

1 Press [DVD] first.
Press [TITLE].

2 Use [▲ / ▼] to select a desired title, then press [OK].

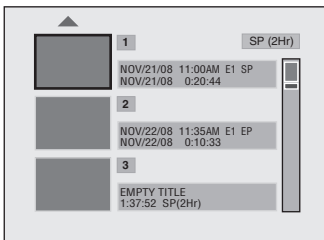

Note

- Deleted part of the titles in the capacity indicator changes in color.
- As for DVD+RW/DVD-RW if you delete the title, deleted title will be displayed as "EMPTY TITLE".

3 Use [▲ / ▼] to select "Edit", then press [OK].

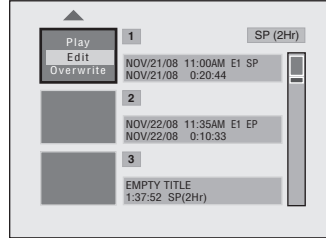

4 Use [▲ / ▼] to select "Title Delete", then press [OK].

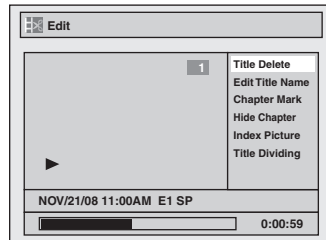

5 Use [▲ / ▼] to select "Yes", then press [OK].

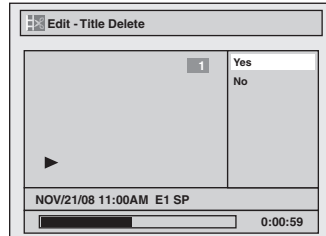

After that, "Are you sure?" will appear, select "Yes" and then press [OK].

Title will be deleted.

Data will be written onto the disc momentarily.



This operation may take a while to be completed.

After editing is complete, the title list will appear. e.g.) DVD+RW/DVD-RW

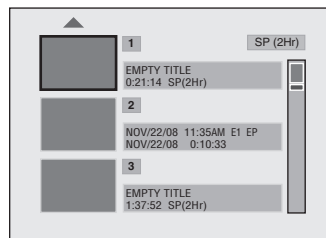

Putting Names on Titles

You can put title names on the titles and change the names from this menu.



1 Follow steps 1 to 3 in "Deleting Titles" on page 58 to display "Edit" menu.

2 Use [▲ / ▼] to select "Edit Title Name", then press [OK].

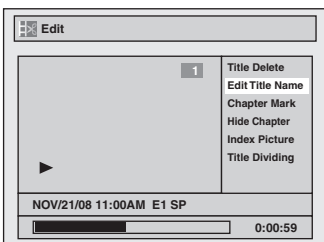

3 To enter a title name, follow the steps of "Guide to Edit Title Name" on this page.

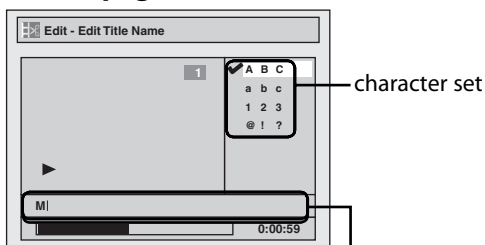

area for entering title names

When you finish entering a title name, press [OK].

4 Use [▲ / ▼] to select "Yes", then press [OK].

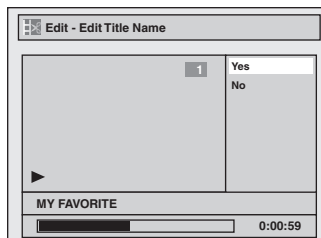

The name you entered will be activated for the title.

5 After this operation is completed, press [RETURN] to exit. Data will be written onto the disc momentarily.

This operation may take a while to be completed.

Guide to Edit Title Name

1) Use [▲ / ▼] to select a desired character set, then press [OK].

2) Follow the list below, use [the Number buttons] repeatedly until the desired letter appears.

Select Press	ABC	abc	123	@!?
0	<space>	<space>	0	<space>
1	(*1)	(*1)	1	!"#\$%&'()* *+,-./:;<=> ?@[]^_`{ }
2	ABC	abc	2	(*2)
3	DEF	def	3	(*2)
4	GHI	ghi	4	(*2)
5	JKL	jkl	5	(*2)
6	MNO	mno	6	(*2)
7	PQRS	pqrs	7	(*2)
8	TUV	tuv	8	(*2)
9	WXYZ	wxyz	9	(*2)

*1 Press ①, character set will be changed to the " @!?" mode automatically.

*2 Press ② to ⑨, character set will be changed to the previous input mode automatically.

• To delete letters, press [CLEAR] repeatedly. Holding [CLEAR] to delete all letters.

• Use [◀ / ▶] to move the cursor to the left and right.

• You can enter up to 30 letters.

Note

• Undefined letters in a title name are shown by " * ". If you delete them, adjoining letters may change to " * " or other.

Setting Chapter Marks

You can put chapter marks in each title. Once a chapter is marked, you can use it for the chapter search feature.



1 Follow steps 1 to 3 in “Deleting Titles” on page 58 to display “Edit” menu.

2 Use [▲ / ▼] to select “Chapter Mark”, then press [OK].
Submenu will appear.

3 Press [PLAY ►] and then [PAUSE ■] to decide the point at which you will create a new chapter mark.

- It is convenient to use [PREV ◀◀], [NEXT ▶▶], [◀◀] and [▶▶] for finding the point to add a new chapter mark.

4 Use [▲ / ▼] to select “Add”, then press [OK].

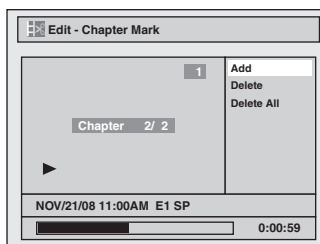

5 Use [▲ / ▼] to select “Yes”, then press [OK].

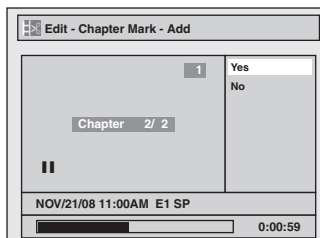

A new chapter mark will be added.

6 Press [RETURN] twice to exit.
Data will be written onto the disc momentarily.

This operation may take a while to be completed.

Note

- When the number of chapter marks in a title is 99 and the number of chapter marks in a disc is 254, chapter marks cannot be added.
- Besides the above-mentioned, it may not be possible to add more of the chapter marks depending on the recorded time and the number of chapters.
- Remaining time of the disc may decrease when adding chapter marks or increase when clearing chapter marks depending on the recording time or edited contents.

Clearing Chapter Marks



1 Follow steps 1 to 3 in “Deleting Titles” on page 58 to display “Edit” menu.

2 Use [▲ / ▼] to select “Chapter Mark”, then press [OK].
Submenu will appear.

3 Use [PREV ◀◀] / [NEXT ▶▶] to select a chapter mark to be deleted.

4 Use [▲ / ▼] to select “Delete”, then press [OK].

5 Use [▲ / ▼] to select “Yes”, then press [OK].

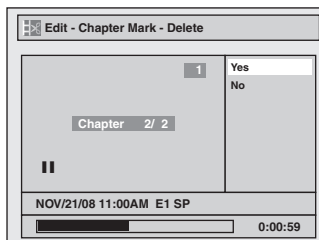

The selected chapter mark will be deleted.

6 Press [RETURN] twice to exit.
Data will be written onto the disc momentarily.

This operation may take a while to be completed.

Note

- Remaining time of the disc may decrease when adding chapter marks or increase when clearing chapter marks depending on the recording time or edited contents.

Clearing Chapter Marks (cont'd)



To delete all chapter marks:

1 Follow steps 1 to 3 in “Deleting Titles” on page 58 to display “Edit” menu.

2 Use [▲ / ▼] to select “Chapter Mark”, then press [OK].
Submenu will appear.

3 Use [▲ / ▼] to select “Delete All”, then press [OK].

4 Use [▲ / ▼] to select “Yes”, then press [OK].

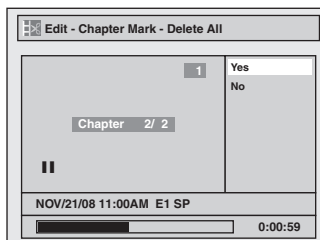

5 Use [▲ / ▼] to select “Yes”, then press [OK].

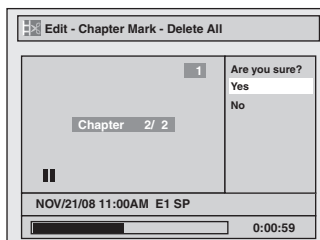

All chapter marks will be deleted.

6 Press [RETURN] twice to exit.
Data will be written onto the disc momentarily.

This operation may take a while to be completed.

Note

- Remaining time of the disc may decrease when adding chapter marks or increase when clearing chapter marks depending on the recording time or edited contents.

Hiding Chapters

You can hide chapters from the title list.
Hidden chapters are skipped during playback.



1 Follow steps 1 to 3 in “Deleting Titles” on page 58 to display “Edit” menu.

2 Use [▲ / ▼] to select “Hide Chapter”, then press [OK].
Submenu will appear.

3 Use [PREV ◀◀] / [NEXT ▶▶] to decide the chapter to be hidden.

4 Use [▲ / ▼] to select “Hidden”, then press [OK].

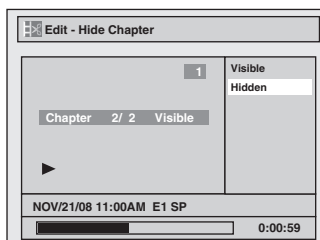

5 After this operation is completed, press [RETURN] twice to exit.
Data will be written onto the disc momentarily.

This operation may take a while to be completed.

If you want hidden chapters to be “Visible”, select the chapter to be shown. Then use [▲ / ▼] to select “Visible” at the step 4 on this page.

Data will be written onto the disc momentarily.
After that, title list is displayed.

Note

- “Hidden” will be displayed in the preview window while previewing the hidden chapter.
- When you make all chapters in the title “Hidden”, “Hidden” is displayed in a thumbnail of the title list.

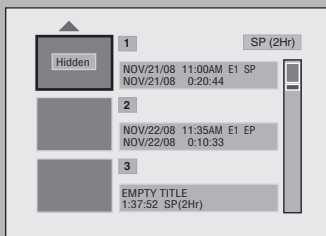

Setting Pictures for Thumbnails

You can set your desired scene as a thumbnail for each title.

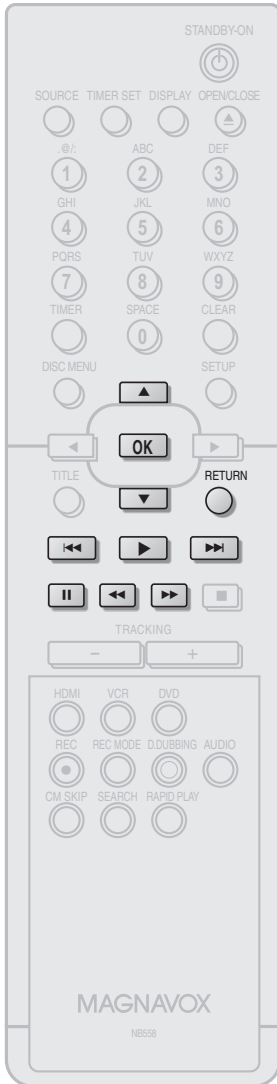

1 Follow steps 1 to 3 in “Deleting Titles” on page 58 to display “Edit” menu.

2 Use [PREV ◀◀], [NEXT ▶▶], [◀◀], [▶▶], [PAUSE ||] and [PLAY ▶] to decide the picture you want to select as a thumbnail.

3 Use [▲ / ▼] to select “Index Picture”, then press [OK].

4 Use [▲ / ▼] to select “Yes”, then press [OK].

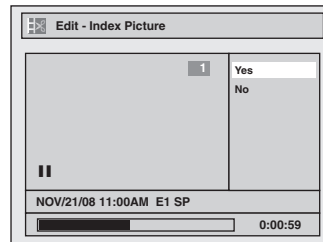

A picture for thumbnail will be set.

5 Press [RETURN] to exit. Data will be written onto the disc momentarily.

This operation may take a while to be completed.

Note

- If the selected picture for a thumbnail is overwritten, the index picture is reset to the first scene of the title.

Dividing a Title



You can divide one title into 2 new titles.



1 Follow steps 1 to 3 in “Deleting Titles” on page 58 to display “Edit” menu.

2 Use [PREV ◀◀], [NEXT ▶▶], [◀◀], [▶▶], [PAUSE ||] and [PLAY ▶] to decide the point at which you will divide the title.

3 Use [▲ / ▼] to select “Title Dividing”, then press [OK].

4 Use [▲ / ▼] to select “Yes”, then press [OK].

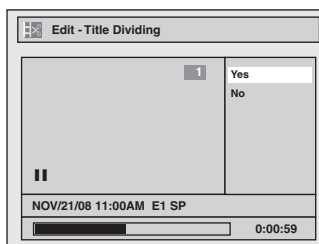

The title will be divided into 2 new titles. Both title names are identical, and index pictures are reset to the first scene at this point.

Data will be written onto the disc momentarily.

This operation may take a while to be completed.

Note

- You cannot divide a title of the disc when the number of recording titles reaches the maximum of 49, and the number of recording chapters reaches the maximum of 254.

Putting Name on Disc

You can put a name on the disc and change it from this menu.



Press [STOP ■] if you are playing back a disc.

1 Press [DVD] first.
Press [SETUP].

2 Use [▲ / ▼] to select "Disc Edit", then press [OK].

3 Use [▲ / ▼] to select "Edit Disc Name", then press [OK].
e.g.) DVD+RW

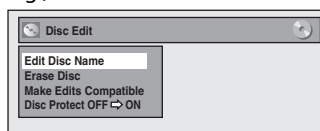

A window for entering a title name will appear.

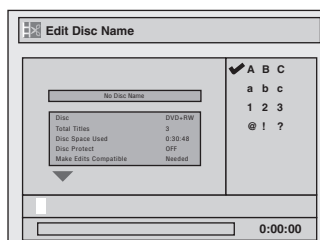

4 To enter a disc name, follow the steps of "Guide to Edit Title Name" on page 59.

When you finish entering a title name, press [OK].

5 Use [▲ / ▼] to select "Yes", then press [OK].

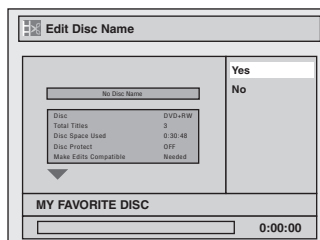

The name you entered will be activated for the title. Data will be written onto the disc momentarily.

This operation may take a while to be completed.

Note

- You cannot select "Disc Edit" when finalized DVD+R or DVD-R is inserted.

Setting or Releasing Disc Protect

To prevent accidental editing or erasing the titles, you can protect them.

Press **[STOP ■]** if you are playing back a disc.

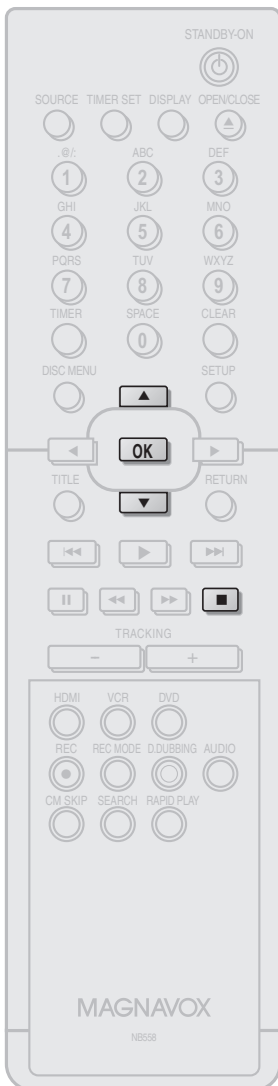

1 Follow steps 1 to 2 in “Putting Name on Disc” on page 66 to display “Disc Edit” menu.

2 Use **[▲ / ▼]** to select “Disc Protect OFF → ON”, then press **[OK]**.
e.g.) DVD+RW

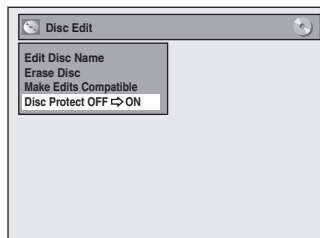

- If the disc is already protected, “Disc Protect ON → OFF” will appear instead of “Disc Protect OFF → ON”.

3 Use **[▲ / ▼]** to select “Yes”, then press **[OK]**.

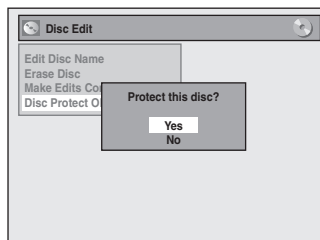

Data will be written onto the disc momentarily.

This operation may take a while to be completed.

Erasing Disc



You can erase all titles on a disc.

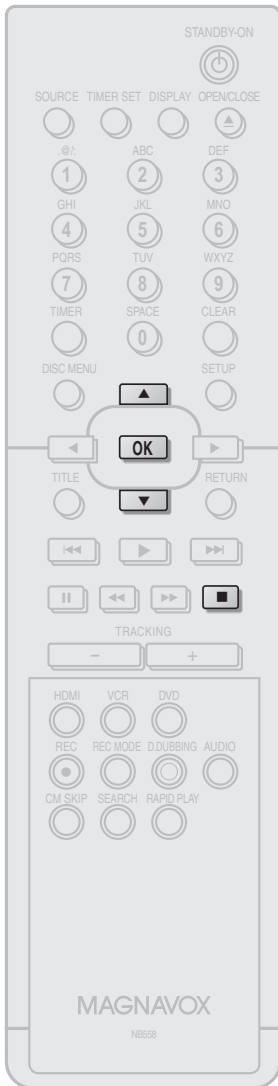

Press [STOP ■] if you are playing back a disc.

1 Follow steps 1 to 2 in “Putting Name on Disc” on page 66 to display “Disc Edit” menu.

2 Use [▲ / ▼] to select “Erase Disc”, then press [OK].
e.g.) DVD+RW

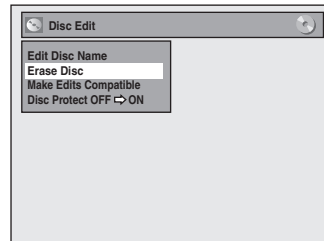

3 Use [▲ / ▼] to select “Yes”, then press [OK].

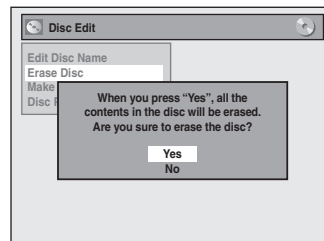

Data will be written onto the disc momentarily.

This operation may take a while to be completed.

Note

- When you select “Yes” at step 3, all contents of the disc will be erased.

Making Edits Compatible



If you have added or deleted chapters, or made chapters hidden, you must perform "Make Edits Compatible" to see those effects on other unit.

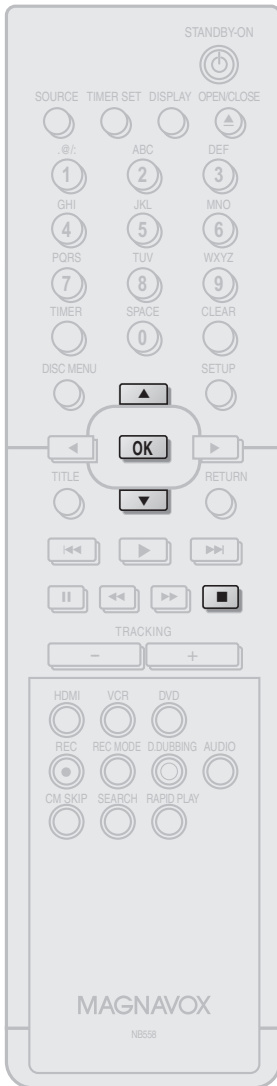

Press [STOP ■] if you are playing back a disc.

1 Follow steps 1 to 2 in "Putting Name on Disc" on page 66 to display "Disc Edit" menu.

2 Use [▲ / ▼] to select "Make Edits Compatible", then press [OK].

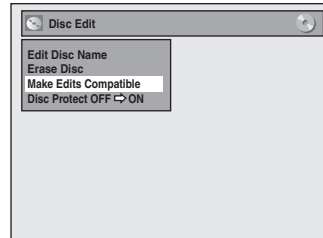

3 Use [▲ / ▼] to select "Yes", then press [OK].

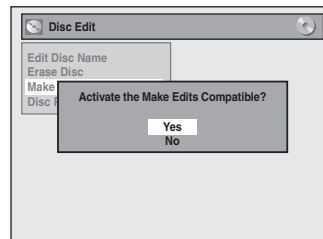

Data will be written onto the disc momentarily.

This operation may take a while to be completed.

LIST OF SETTINGS

The following table is the contents which you can set and the default setting. Refer to the following table for useful operation.

Setup	Items (highlight is the default)		Contents		
General Setting	Playback → Pages 72-74	Parental Lock	OFF level 8 [Adult] to 1 [Kid Safe]	Set the parental level for DVD playback.	
		Disc Audio	Dynamic Range Control	ON OFF	Compressing the range of sound volume.
			PCM	48kHz 96kHz	Set whether the sound recorded in 96kHz will be down sampled in 48kHz.
				Dolby Digital	PCM Stream
		Disc Menu Language		English French Spanish Other	Set the language for disc menu language.
		Audio Language		Original English French Spanish Other	Set the language for audio.
		Subtitle Language		OFF English French Spanish Other	Set the language for subtitles.
		Angle Icon		ON OFF	Set whether or not to display the angle icon.
		Still Mode		Auto Field Frame	Set the type of still image in pausing playback.
		Display → Page 75	OSD Language		English Français Español
Screen Saver			OFF 5minutes 10minutes 15minutes 30minutes	Set the idling time before the screen saver starts.	
FL Dimmer			Auto Bright Dark	Set the brightness of the front panel display.	
Video → Page 76	Progressive Scan		ON OFF	Set to the progressive scan mode (set to "ON") or to the interlace scan mode(set to "OFF").	
	TV Aspect		4:3 Letter Box 4:3 Pan & Scan 16:9 Wide	Set a picture size according to aspect ratio of your TV.	
	Video Input → Page 15	E1(Rear)	Video In S-Video In	Set the video input type for the external input.	
E2(Front)		Video In S-Video In			

LIST OF SETTINGS

Setup	Items (highlight is the default)	Contents		
General Setting	Recording	Auto Chapter → Page 25	OFF 5 minutes 10 minutes 15 minutes 30 minutes 60 minutes	Insert chapter marks at even time interval.
		Auto Finalize → Page 39	Disc Full ON OFF	Set the unit to finalize the disc automatically.
		End of Timer Rec	ON OFF	
		Dubbing Mode → Pages 40-41	VCR → DVD DVD → VCR	Set the VCR to DVD (DVD to VCR) duplication.
		Make Recording Compatible → Page 25	ON OFF	Set to prohibiting additional recording (OFF) or to replace the title list after recording (ON).
	Clock → Page 23	Clock Setting		Set the clock.
HDMI		Format → page 77	RGB YCbCr	Set the color space for the HDMI output.
		HDMI Audio → page 77	ON OFF	Set whether to output the HDMI audio signal or not.
		RGB Range → page 77	Normal Enhanced	Set the black-white contrast level for HDMI RGB output.
	Reset All → Page 78	Yes No		Set to the default setting.

Note

- Your change to each settings stays on even when the power is off.
- An item not currently available is grayed in the settings.

Introduction

Connections

Basic Setup

Recording

Playback

Editing

Function Setup

VCR Functions

Others

Español

SETUPS

Playback



3 Use [▲ / ▼] to select a desired item, then press [OK].

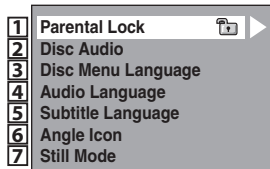

Submenu will appear.

4 Refer to **1** to **7** on pages 72-74 and set the selected item.

5 When you finish with setting, press [SETUP] to exit.

1 Parental Lock (Default: OFF)

Some DVD-video feature a parental lock level. If the ratings exceed the levels you set, playback will stop and the disc will require you to enter a password before it begins playback. This feature prevents your children from viewing inappropriate material.

Use [▲ / ▼] to select the desired level, then press [OK].

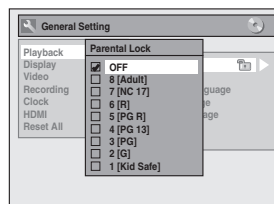

If a password has not been set yet, proceed to **A**.

If a password has been set already, proceed to **B**.

Press [STOP ■] if you are playing back a disc.

1 Press [SETUP] and use [▲ / ▼] to select "General Setting", then press [OK].

"General Setting" menu will appear.

2 Use [▲ / ▼] to select "Playback", then press [OK].

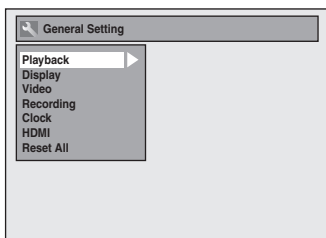

Note

- Parental lock function may not be available to some discs.
- With some DVD, it may be difficult to find if they are compatible with parental lock. Be sure to check if the parental lock function operates in the way that you have set.
- Record the password in case you forget it.
- If there is a DVD in the unit when you set up the parental lock, press [OPEN/CLOSE ▲] to activate the parental lock level.

Playback (cont'd)

A A password has not been set yet.

Use **[▲ / ▼]** to select “Yes”. Use **[the Number buttons]** to enter a new password except for 4737, then press **[OK]**.

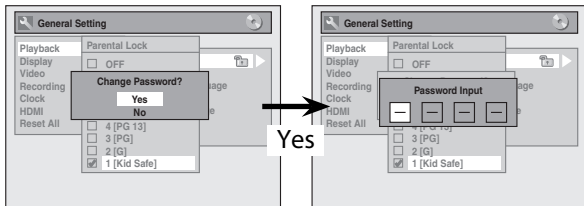

Your setting will be activated.

B A password has been set already.

• Use **[the Number buttons]** to enter the current password.

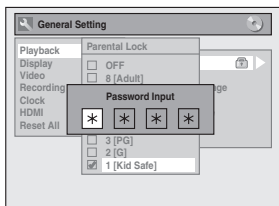

Your setting will be activated.

• If you want to change password, use **[▲ / ▼]** to select “Yes”. Use **[the Number buttons]** to enter a new password, then press **[OK]**.

<change the password>

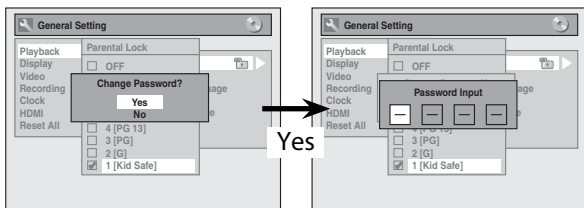

Your setting will be activated.

Note

- Press **[CLEAR]** to erase numbers entered incorrectly.
- When you forget the password or you want to clear all settings in “Parental Lock” menu, enter 4,7,3,7 using **[the Number buttons]** in password input window. Password will be cleared and parental levels will be set to “OFF”.

2 **Disc Audio**

Choose the appropriate audio setting for your external device. It will only affect a disc playback.

Use **[▲ / ▼]** to select a desired item, then press **[OK]**.

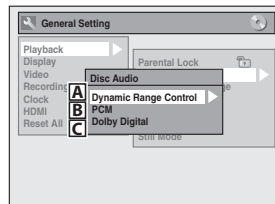

A **Dynamic Range Control (Default : ON)**

Set to “ON” to compress the range between soft and loud sounds.

Use **[▲ / ▼]** to select a setting, then press **[OK]**.

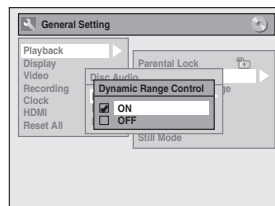

Your setting will be activated.

Note

- Dynamic range control function is available only on the discs which are recorded in the Dolby Digital format.

B **PCM (Default : 48kHz)**

Use **[▲ / ▼]** to select a setting, then press **[OK]**.

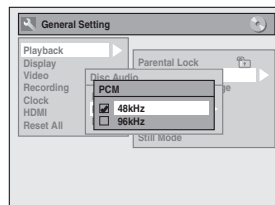

Your setting will be activated.

48kHz : If your amplifier/decoder is NOT compatible with 96kHz PCM, select “48kHz”. 96kHz sound will be output in 48kHz.

96kHz : If your amplifier/decoder is compatible with 96kHz PCM, select “96kHz”. 96kHz sound will be output.

Note

When playing back disc with copyright protection

- Even if you select “96kHz”, the sound will be down sampled at 48kHz.

Playback (cont'd)

C Dolby Digital (Default : Stream)

Use **[▲ / ▼]** to select a setting, then press **[OK]**.

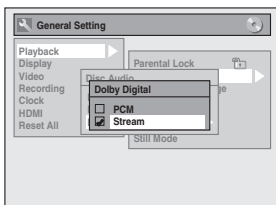

Your setting will be activated.

PCM : Converts the Dolby Digital into PCM (2 channel). When your amplifier/decoder is NOT compatible with Dolby Digital, set to "PCM".

Stream : Outputs Dolby Digital signals. When your amplifier/decoder is compatible with Dolby Digital, set to "Stream".

3 Disc Menu Language (Default : English)

Set the language for disc menu.

Use **[▲ / ▼]** to select a setting, then press **[OK]**.

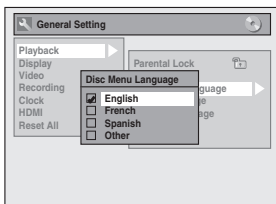

Your setting will be activated.

4 Audio Language (Default : Original)

Set the audio language.

Use **[▲ / ▼]** to select a setting, then press **[OK]**.

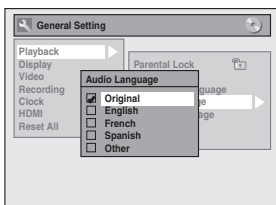

Your setting will be activated.

• When "Original" is selected, the audio language will be in the disc's default language.

5 Subtitle Language (Default : OFF)

Set the subtitle language.

Use **[▲ / ▼]** to select a setting, then press **[OK]**.

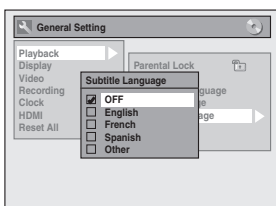

Your setting will be activated.

If "Other" is selected for **[3]** to **[5]**, press 4-digit code using **[the Number buttons]**.



• When you finish entering the code, press **[OK]**. Refer to the language code table on page 85.

Note

- Only the languages supported by the disc can be selected.
- Audio language setting may not be available to some discs.
- You can change or switch off the subtitles on a DVD also from the disc menu if it is available.
- Press **[CLEAR]** or **[◀]** to erase numbers entered incorrectly.

6 Angle Icon (Default : ON)

Set to "ON" to show the angle icon during the playback.

Use **[▲ / ▼]** to select a setting, then press **[OK]**.

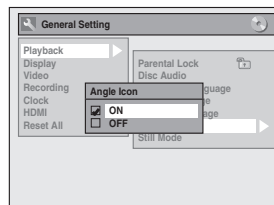

Your setting will be activated.

7 Still Mode (Default : Auto)

Select "Auto" usually.

Use **[▲ / ▼]** to select a setting, then press **[OK]**.

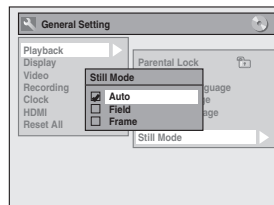

Your setting will be activated.

Auto : Optimum resolution setting ("Field" or "Frame") will be selected.

Field : Images in the still mode will be stabilized.

Frame : Images in the still mode will be highly defined.

Note

- Frame is 1 completed video image made up of 2 fields (There are 30 frames per second of NTSC video).



Press [STOP ■] if you are playing back a disc.

1 Press [SETUP] and use [▲ / ▼] to select "General Setting", then press [OK].

2 Use [▲ / ▼] to select "Display", then press [OK].

3 Use [▲ / ▼] to select a desired item, then press [OK].

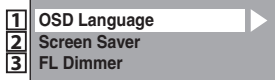

Selection menu will appear.

4 Refer to **1** to **3** on this page and set the selected item.

5 When you finish with setting, press [SETUP] to exit.

1 OSD Language (Default : English)

Set the language for the on-screen display.

Use [▲ / ▼] to select a setting, then press [OK].

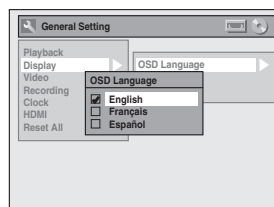

Your setting will be activated.

2 Screen Saver (Default : 10 minutes)

Set the time to activate the screen saver function on the TV screen.

Use [▲ / ▼] to select a setting, then press [OK].

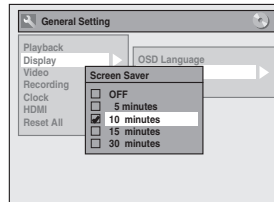

Your setting will be activated.

3 FL Dimmer (Default: Bright)

Set the front panel display brightness.

Use [▲ / ▼] to select a setting, then press [OK].

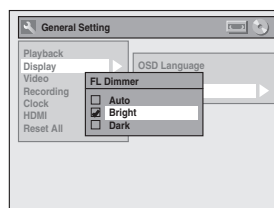

You can choose one from "Auto", "Bright" and "Dark". If "Auto" is selected, the display gets dark when the power is off.

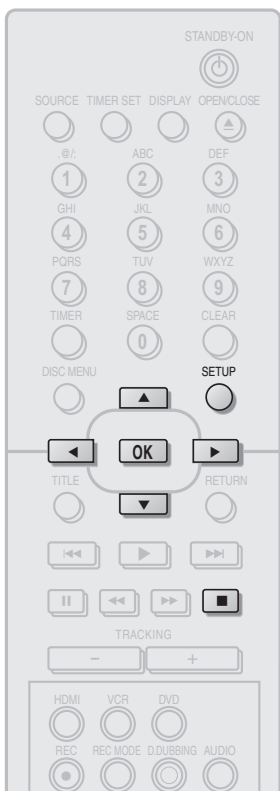

Press [STOP ■] if you are playing back a disc.

1 Press [SETUP] and use [▲ / ▼] to select “General Setting”, then press [OK].

2 Use [▲ / ▼] to select “Video”, then press [OK].

3 Use [▲ / ▼] to select a desired item, then press [OK].

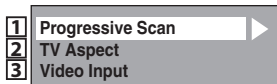

Submenu will appear.

4 Refer to **1** to **2** on page 76 and set the selected item.

• For **3** refer to page 15.

5 When you finish with setting, press [SETUP] to exit.

1 Progressive Scan (Default : OFF)

This unit is compatible with the progressive scan system. The feature provides you with the higher definition images than the traditional output system does. To utilize this feature, you must set progressive scan mode to “ON”.

1) Use [▲ / ▼] to select “ON”, then press [OK].

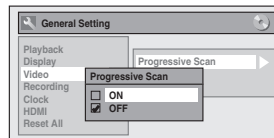

2) Use [◀ / ▶] to select “Yes”, then press [OK].

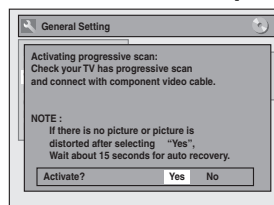

3) Use [▲ / ▼] to select “Yes” within 15 seconds, then press [OK].

Your setting will be activated.

Note

- If your TV is compatible with progressive scan (525p / 480p), you are recommended to use the HDMI or component video cable (commercially available) to connect this unit to the TV. (Refer to “Method 2” on page 16, or page 17.) If not, use the RCA video cable and set the progressive scan to “OFF” or press and hold [SETUP] for more than 3 seconds during DVD playback.
- When selecting “No” or not pressing any buttons on the unit or remote control within 15 seconds at step 3, progressive scan remains to be “OFF” (interlace scan).

2 TV Aspect (Default: 4:3 Letter Box)

You should select the TV aspect ratio to match the TV you are connecting to the unit. You either have a standard 4:3 TV or a widescreen TV (16:9 rectangular).

Use [▲ / ▼] to select your desired option, then press [OK].

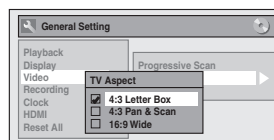

If you have a standard TV:

Select “4:3 Letter Box” or “4:3 Pan and Scan”. The “4:3 Letter Box” setting will display the entire widescreen DVDs on your standard TV, by placing black bars at the top and bottom of the picture, like a normal DVD player does. The “4:3 Pan and Scan” setting will fill the screen vertically, but both sides of the widescreen DVDs will be trimmed. Standard video input and standard DVDs will appear normal with either setting.

If you have a widescreen TV:

Select the “16:9 Wide” setting. Widescreen DVDs will fill the screen appropriately. To watch standard 4:3 video, use your TV’s aspect control to set the screen to your liking.



Press [STOP ■] if you are playing back a disc.

1 Press [SETUP] and use [▲ / ▼] to select “General Setting”, then press [OK].

2 Use [▲ / ▼] to select “HDMI”, then press [OK].

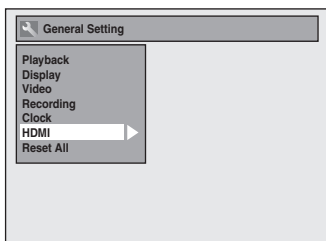

- You cannot select HDMI when an HDMI cable is not connected and the item is shown in grey color.

3 Use [▲ / ▼] to select a desired item, then press [OK].

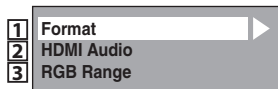

4 When you finish with the setting, press [SETUP] to exit.

1 Format (Default : RGB)

You can select the color space for HDMI output. Set the appropriate color space for your display device.

Use [▲ / ▼] to select a setting, then press [OK].

- When the connected device is not compatible with the Y/Cb/Cr, HDMI signal is output as RGB regardless of the setting.

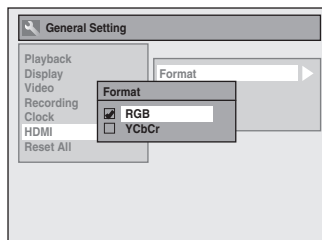

Your setting will be activated.

2 HDMI Audio (Default : ON)

If you do not want to output the audio through HDMI (when you digitally output the audio through the COAXIAL DIGITAL AUDIO OUT jack to your audio system, etc.), you can set the HDMI audio output off.

Use [▲ / ▼] to select a setting, then press [OK].

- Set to “OFF” when the HDMI sound is not output.

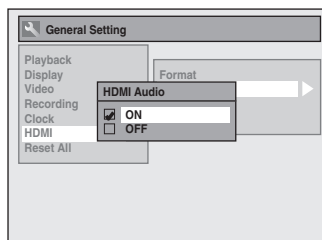

Your setting will be activated.

3 RGB Range (Default : Normal)

You can adjust the RGB range to make the dark areas of the HDMI images brighter.

Use [▲ / ▼] to select a setting, then press [OK].

- Select “Enhanced” if the black-white contrast is not clear.
- This setting is effective only for HDMI RGB output.

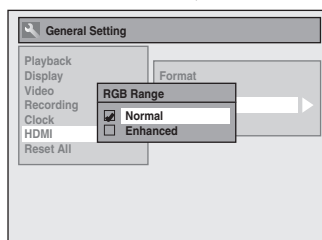

Your setting will be activated.

SETUPS

Reset All

Reset the setting to default.

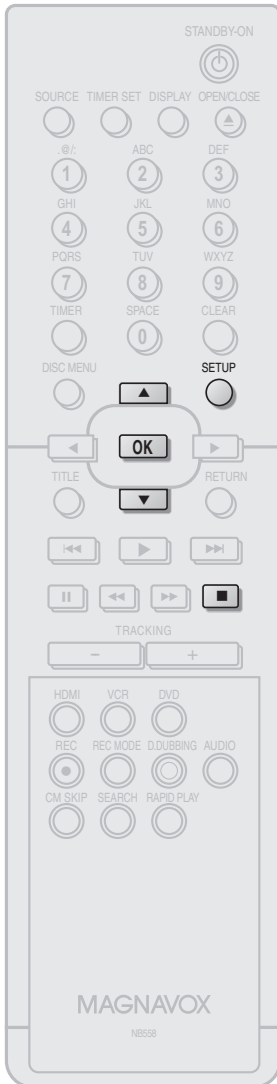

Press [STOP ■] if you are playing back a disc.

1 Press [SETUP] and use [▲ / ▼] to select "General Setting", then press [OK].
"General Setting" menu will appear.

2 Use [▲ / ▼] to select "Reset All", then press [OK].

3 Select "Yes" using [▲ / ▼], then press [OK].

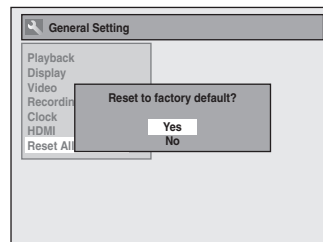

4 Select "Yes" again using [▲ / ▼], then press [OK].

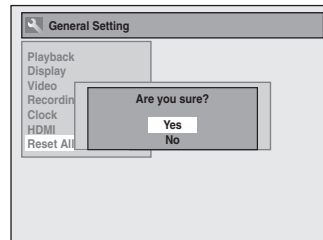

Your setting in recording will be initialized.

Note

- The settings listed below will remain unchanged even after resetting to the factory default.
 - OSD language setting
 - Clock setting
 - Parental lock setting
 - Timer programming information

VCR FUNCTIONS

Playback



1) Press [STANDBY-ON ] on the remote control or the front panel of the unit.

When you are playing back a cassette tape, turn the TV on and be sure to select the input to which the unit is connected.

Press [VCR].

2) Insert a prerecorded cassette tape. Press [PLAY ] to begin playback.

3) During playback, press [PAUSE ].



Playback will pause and sound will be muted.

4) Press [PLAY ] to resume playback.

5) Press [STOP ] to stop playback.

6) Press [STOP  / EJECT ] on the front panel of the unit to eject the cassette tape.

Note

- When a cassette tape without erase-protection tab is inserted, the unit will start playback automatically.
- Tracking will be automatically adjusted upon playback. To adjust the tracking manually, press [TRACKING  / ].

Recording



Press [VCR] first.

Before recording, make sure:

- The appropriate external input position (E1/E2) to which your external tuner is connected is selected by pressing [SOURCE].
- There is a cassette tape with a erase-protection tab in the unit.
- The desired recording mode is selected in SP (standard playback) or SLP (super long playback) mode by pressing [REC MODE].

Recording mode:

Tape speed	Recording / playback time		
Type of tape	T60	T120	T160
SP mode	1hour	2hours	2-2/3hours
SLP mode	3hours	6hours	8hours

- Refer to pages 28-31 for instructions on timer recording.

1) Press [REC ] to begin the recording.

To temporarily stop recording or to resume it, press [PAUSE ]. After the unit has been in pause mode for 5 minutes, it will stop automatically to protect the cassette tape and the video head from damage.

2) Press [STOP ] when the recording is completed.

Accidental erasure prevention

To prevent accidental recording on a recorded cassette tape, remove its erase-protection tab. To record on it later, cover the hole with cellophane tape.

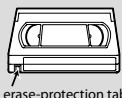

erase-protection tab

One-touch Timer Recording (OTR)



This feature allows you to set the recording length simply by pressing [REC ] on the remote control.

Press [VCR] first.

1) During normal recording, press [REC ] to begin the one-touch timer recording.

You can select a fixed recording time by pressing [REC ] repeatedly.

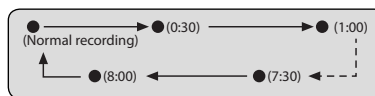



When the one-touch timer recording is finished, the unit will turn off automatically.

To change the recording length during the one-touch timer recording, press [REC ] repeatedly until the desired length appear.

To cancel the one-touch timer recording within the specified time, press [STOP ].

Note

- To see the remaining recording time on the TV screen during the one-touch timer recording, press [DISPLAY].
- You cannot pause the one-touch timer recording.
- If VCR the one-touch timer recording is completed during DVD playback or recording, the VCR will be in stop mode and the DVD keeps the current mode.
- Unlike a timer recording, you can perform the following operations during the one-touch timer recording.
 - Turning off the power to stop one-touch timer recording.
 - Using [REC ] or [STOP ].
- When the one-touch timer recording is finished and the power is turned off, the unit will switch to the standby mode automatically if a timer recording has been programmed. Press [TIMER SET] to cancel the standby mode for using the unit continuously.

VCR FUNCTIONS

Index Search



An index mark will be assigned at the beginning of each recording you make. You may skip to a specific marked point by following the steps below.

Press [VCR] first.

- 1) Press [SEARCH] so that "INDEX SEARCH" menu appears.
- 2) Using [the Number buttons], enter the number of recordings you wish to skip within 30 seconds.

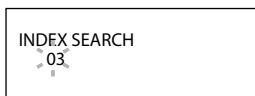

3) Press [◀◀], [▶▶] to start index search.

If you want to go in the forward direction, press [▶▶].

If you want to go in the reverse direction, press [◀◀].

After index search, the VCR will play back the cassette tape automatically.

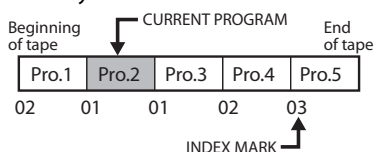

Note

- You can make the index mark up to 20.

Time Search



This feature allows you to go to a specific point on a cassette tape by entering the exact amount of time you wish to skip in order to reach the point.

Press [VCR] first.

- 1) Press [SEARCH] repeatedly so that "TIME SEARCH" menu appears.
- 2) Using [the Number buttons], enter your desired time to skip within 30 seconds.

You can set the time up to 9:59.

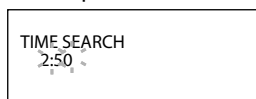

3) Press [◀◀], [▶▶] to start time search.

If you want to go in the forward direction, press [▶▶].

If you want to go in the reverse direction, press [◀◀].

After time search, the unit will play back the cassette tape automatically.

Note

- Index search and time search are not available during recording.
- Press [STOP ■] to stop the search.
- If the end of the cassette tape is reached during search, this unit will cancel the search and rewind the cassette tape.

Other Operations



Press [VCR] first.

Fast forward:

When the unit is in stop mode, press [▶▶] to fast forward the cassette tape.

Rewind:

When the unit is in stop mode, press [◀◀] to rewind the cassette tape.

To cue or review picture during playback (picture search):

Press [◀◀], [▶▶] during playback.

Press it again and the unit will search in super high speed. (in the SLP mode only)

To freeze the picture on TV screen during playback (still mode):

Press [PAUSE II]. Each time you press the button, the picture will be forwarded by one frame.

If the picture begins to vibrate vertically during the still mode, stabilize the picture by pressing [TRACKING + / -] on remote control.

If the picture is distorted or rolling vertically, adjust the vertical hold control on your TV, if equipped.

Counter reset:

Press [CLEAR] to reset the counter to "0:00:00".

To playback in slow motion:

Press [PAUSE II] during playback, then press [▶▶].

Press [▶▶] or [◀◀] repeatedly to select the desired speed.

Automatic rewind:

When a cassette tape is played back or fast forwarded to its end, the cassette tape will rewind to the beginning, stop and eject itself.

When you playback a cassette tape recorded in Hi-Fi stereo:

Press [AUDIO] on the remote control to select Hi-Fi or MONO for playback sound mode.

- If you have connected a stereo TV to this unit, select "HIFI".
- If you have connected a monaural TV to this unit, select "MONO".

Your Selection Type of recorded tape	HIFI		MONO
	L-channel	R-channel	
non Hi-Fi tapes	Monaural	Monaural	Monaural
Hi-Fi tapes recorded in Hi-Fi stereo	L	R	L+R
Hi-Fi tapes recorded main audio program	Main audio program	Main audio program	Main audio program
Hi-Fi tapes recorded second audio program	Second audio program	Second audio program	Second audio program

Note

- Still/slow mode will stop after 5 minutes to prevent damage to the cassette tape and the video head.
- To return to playback from the picture search/still/slow mode, press [PLAY ▶].

TROUBLESHOOTING

Before requesting service for this unit, check the table below for a possible cause of the problem you are experiencing. Some simple checks or a minor adjustment on your part may eliminate the problem and restore proper operation.

Symptom	Remedy
The power does not turn on.	<ul style="list-style-type: none"> • Check that the AC power cord is connected securely. • Check the breaker (in case of power failure). • Press [TIMER SET] to cancel the timer standby mode.
There is no picture.	<ul style="list-style-type: none"> • Re-connect the connecting cords securely. • Check if the connecting cords are damaged. • Check the connection to your TV (page 16). • Switch the input selector on your TV (such as to "E1") so that the signal from the unit appears on the TV screen.
Cannot record a TV program.	<ul style="list-style-type: none"> • This unit does not have a tuner to receive TV broadcasting. • You must connect this unit to an external tuner to record TV programs (page 13).
TV program pictures are distorted.	<ul style="list-style-type: none"> • Check if all the connections are made correctly.
Playback picture is distorted.	<ul style="list-style-type: none"> • Keep the device which may cause electrical disturbances, such as a cellular phone, away.
There is no sound.	<ul style="list-style-type: none"> • Re-connect all connections securely. • Check if the connecting cord is damaged. • Check the connections to the amplifier input. • Check if the input device setting on the amplifier is correct. • When the unit is in pause mode or in slow-motion playback mode, sound is not output. This is not a malfunction. • When the unit is in fast forward or fast reverse mode, sound is not output. This is not a malfunction.
Nothing was recorded even though you set the timer setting correctly.	<ul style="list-style-type: none"> • There was a power failure during recording. • The unit's internal clock stopped due to a power failure that lasted for more than 30 seconds. Reset the clock (page 23). • The program contains copy protection signals that restricts copying. • The timer setting overlapped with another setting that has priority.
Timer recording is not complete or did not start from the beginning.	<ul style="list-style-type: none"> • The timer setting overlapped with another setting that has priority (page 31). • Disc space was not enough.
Timer recording is impossible.	<ul style="list-style-type: none"> • Make sure  appears on the front panel display of this unit. If not, press [TIMER SET].
The remote control does not function.	<ul style="list-style-type: none"> • Batteries are weak. • There are obstacles between the remote control and the unit. • The remote control is far from the unit. • There are no batteries in the remote control. • Check if the unit is turned on. • Check if you are pointing the remote control at the recorder and NOT the TV. If you have a plasma TV, it may interfere with the IR signal. Try the remote with the plasma off. If the remote works, you may need to move the unit away from the plasma TV. • Press [DVD] or [VCR], whichever you need. Then, try again. • Press [TIMER SET] to cancel the timer standby mode.
The unit does not operate properly.	<ul style="list-style-type: none"> • When static electricity, etc., causes the unit to operate abnormally, unplug the unit and then plug it in again.
There is no picture.	<ul style="list-style-type: none"> • If the main menu appears on the TV screen, press [RETURN] to exit. • Check if the progressive scan mode is set correctly according to your TV (page 76).
Picture noise appears.	<ul style="list-style-type: none"> • Clean the disc with a cleaning cloth.
Playback picture from the external devices connected to this unit is distorted.	<ul style="list-style-type: none"> • If the picture output signal from the external devices passes through this unit to get to your TV, the copy protection signal applied to some DVD could affect the picture quality. Disconnect the playback device in question and connect it directly to your TV.
There is no sound.	<ul style="list-style-type: none"> • If you are using DIGITAL AUDIO OUTPUT (COAXIAL) jack, check the setting in "Disc Audio" (pages 73-74). • Clean the disc with a cleaning cloth.

D
V
D
•
V
C
R

D
V
D

Introduction

Connections

Basic Setup

Recording

Playback

Editing

Function Setup

VCR Functions

Others

Español

TROUBLESHOOTING

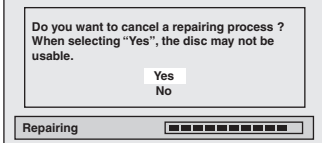
Symptom	Remedy
Sound is noisy.	<ul style="list-style-type: none"> • Clean the disc with a cleaning cloth.
No DTS sound is output.	<ul style="list-style-type: none"> • This unit is not compatible with DTS sound.
The disc does not play back.	<ul style="list-style-type: none"> • No disc is inserted. • A blank disc is inserted. • The disc is upside down. Insert the disc with the labeled side facing up. • The disc is not correctly inserted. • The unit cannot play back certain discs (such as a CD-ROM) (page 42). • The region code on the DVD-video does not match the unit (page 42). • Moisture has condensed inside the unit. Remove the disc and leave the unit turned on for about 2 hours until the moisture evaporates (page 4). • If the disc was recorded on another recorder, the unit cannot play back the disc if it was not finalized.
Discs recorded on this unit cannot be played back on other DVD players.	<ul style="list-style-type: none"> • If you are using DVD+R, DVD-RW/-R disc, please ensure you finalized the disc after recording (page 38).
The disc does not start playback from the beginning.	<ul style="list-style-type: none"> • Resume playback was activated (page 48). Press [STOP ■] twice. • You have inserted a disc whose title menu or DVD menu automatically appears on the TV screen when it is first insert.
The unit starts playing back the disc automatically.	<ul style="list-style-type: none"> • The DVD-video features an auto playback function.
Some functions such as stop, search, or slow-motion playback cannot be performed.	<ul style="list-style-type: none"> • Depending on the disc, you may not be able to do some of the operations. Refer to the manual supplied with the disc.
The language for the sound track cannot be changed.	<ul style="list-style-type: none"> • The title does not have the multilingual audio tracks. • The DVD-video prohibits the changing of the language for the sound track.
The subtitle language cannot be changed or turned off.	<ul style="list-style-type: none"> • Multilingual subtitle are not recorded on the DVD-video.
The angles cannot be changed.	<ul style="list-style-type: none"> • Multi-angles are not recorded on the DVD-video being played back. • The angle-change operation is whenever possible as long as the disc contains a multi-angle portion. Actual change will be performed when the portion has come up. • The DVD-video prohibits changing angles. • Try changing the angle using the DVD-video's menu.
Recording does not stop immediately after you press [STOP ■] .	<ul style="list-style-type: none"> • It may take a few seconds for the unit to input disc data before recording stops.
The disc tray does not open when you press [OPEN/CLOSE ▲] .	<ul style="list-style-type: none"> • It may take a few seconds for the disc tray to open after you have recorded or edited a disc. This is because the unit is adding disc data to the disc.
<p>"Repairing" appears on the TV screen.</p>  <p>In a case you intend to cancel the repairing process.</p> 	<ul style="list-style-type: none"> • If there is a power failure or unplugging during recording, finalizing, formatting or editing (even after "Repairing" disappears), a repairing process will begin automatically just after turning the unit on again. It may take several minutes up to about several hours. • If you intend to cancel the repairing process, press [OPEN/CLOSE ▲] on the front panel, then select "Yes" and press [OK]. After that, press [OPEN/CLOSE ▲] to take out the disc. The disc canceled during the repairing process MAY NOT work.
No sound/image from HDMI connection.	<ul style="list-style-type: none"> • Check the HDMI connection. (Check the status of the HDMI related indications.) • Check whether the connected monitor device or other device supports HDCP. (This unit will not output a video signal unless the other device supports HDCP.) • Check the setting of HDMI. • Check whether the output format of this unit (HDMI FORMAT) matches the supported input format of other connected device. • If the unit is connected to the unauthorized display device with an HDMI cable, the audio/video signal may not be output when playing back a commercial DVD-video.

D
V
D

TROUBLESHOOTING

	Symptom	Remedy
D V D	There is no sound or the sound is distorted.	<ul style="list-style-type: none"> • The HDMI sound is not output when "HDMI Audio" is set to "OFF". • Check the RCA audio cable connection. If you are using HDMI-DVI conversion cable, you must connect the RCA audio cable, too. • Check whether the output format of this unit (HDMI FORMAT) matches the supported input format of other connected device.
	There is no picture.	<ul style="list-style-type: none"> • If you connect the cable to S-VIDEO OUT/ COMPONENT VIDEO OUT / HDMI OUT jack, try connecting it to AUDIO / VIDEO OUT jack instead.
V C R	Picture noise appears.	<ul style="list-style-type: none"> • Head cleaning for VCR may be necessary. Refer to "Auto head cleaning" (page 5). • Adjust tracking control for better picture by pressing [TRACKING + / -] while you are playing back a cassette tape.
	The cassette tape does not play back.	<ul style="list-style-type: none"> • No cassette tape is inserted.
	Recording does not start after you press [REC ●] .	<ul style="list-style-type: none"> • Make sure the cassette tape has an erase-protection tab when you record to a cassette tape. If needed, cover the hole with cellophane tape.
	The remote control does not function.	<ul style="list-style-type: none"> • Check if a cassette tape is in this unit.
	The motor rotates even when playback / recording is stopped.	<ul style="list-style-type: none"> • The motor may rotate for the duration of approximately 5 minutes for efficient operation. This is not a malfunction.

Frequently Asked Questions

- Can I record to CD-RW/-R?	No, this unit records only DVD.
- Can I play back DVD-video that is bought in another country?	Possible when the region code of the disc is 1 and All.
- Can I connect the unit to my PC?	No, you cannot control the unit by PC.
- Can I program a timer recording with external tuner?	Yes, you can. Select "E1" or "E2" as your recording channel, and leave the external tuner on (pages 13, 28-31).
- Can I record one channel while watching another channel using an external tuner?	It depends on your connection configurations. For more details, please kindly contact at your local store.
- Can I change the channels on the external tuner using the remote control of this unit?	No. Changing the channels on the external tuner using this unit's remote control is not possible. You need to use the remote control supplied with the external tuner to change the channels on the external tuner.

TROUBLESHOOTING

Error message	Cause	Solution
Disc Error — Please eject the disc. — Playback feature may not be available on this disc.	<ul style="list-style-type: none"> • Unplayable disc is inserted in the unit. • The disc is upside down. 	<ul style="list-style-type: none"> • Insert the standardized disc which bears the marks on page 42. • Insert the disc with the labeled side facing up.
Region Error — Please eject the disc. — Playback is not authorized in your region.	<ul style="list-style-type: none"> • Playback is not authorized in the region of the DVD-video which you inserted in the unit. 	<ul style="list-style-type: none"> • Insert the DVD-video with region codes 1 or ALL.
Parental Lock On The current selected parental level prohibits playback.	<ul style="list-style-type: none"> • The current selected parental level prohibits playback. 	<ul style="list-style-type: none"> • Check “Parental Lock” setting in “Playback” menu (pages 72-73).
Recording Error This program is not allowed to be recorded.	<ul style="list-style-type: none"> • The recording function encountered the copy prohibited program. 	<ul style="list-style-type: none"> • You cannot record copy prohibited programs.
Recording Error This program is not recordable in +VR mode.	<ul style="list-style-type: none"> • You are trying to record the copy-once program. 	<ul style="list-style-type: none"> • You cannot record the copy-once program.
Recording Error Can not record on this disc.	<ul style="list-style-type: none"> • You are trying to record onto the disc which is unrecordable, or the disc status is unable to record. • The disc is dirty. • The disc is damaged. 	<ul style="list-style-type: none"> • Insert the recordable disc, and ensure the disc status satisfies the recording requirements (page 24). • Clean the disc with a cleaning cloth. • Replace the disc.
Recording Error This disc is protected and not recordable.	<ul style="list-style-type: none"> • You are trying to record on to the protected disc which is set in “Disc Edit” menu. 	<ul style="list-style-type: none"> • Release the disc protect setting in “Disc Edit” menu (page 37).
Recording Error Disc is full. (No area for new recording)	<ul style="list-style-type: none"> • You are trying to record onto the disc which has no space for recording. 	<ul style="list-style-type: none"> • Insert the recordable disc with enough recording space.
Recording Error You cannot record more than 49 titles on one disc. (The maximum is 49)	<ul style="list-style-type: none"> • You are trying to record onto the disc on which the number of recording titles comes up to the maximum (49). 	<ul style="list-style-type: none"> • Delete unnecessary titles (page 58).
Recording Error You cannot record more than 254 chapters on one disc. (The maximum is 254)	<ul style="list-style-type: none"> • You are trying to record onto the DVD+RW or DVD-RW on which the number of recording chapters comes up to the maximum (254). 	<ul style="list-style-type: none"> • Delete unnecessary chapter marks (pages 61-62).
Recording Error You cannot record on this disc as Power Calibration Area is full.	<ul style="list-style-type: none"> • When recordings are performed repeatedly onto an unstable disc, this area may come up to be full. • Every time you insert a disc for recording, the disc’s working area will be taken up. And if you repeat this frequently, it will be used up sooner and you may not be able to record full 49 titles. 	<ul style="list-style-type: none"> • Insert a new disc.
Recording Error This disc is already finalized.	<ul style="list-style-type: none"> • You are trying to record onto the disc already finalized. 	<ul style="list-style-type: none"> • Release the finalizing for this disc (page 38).
Recording Error The disc has no recording compatibility. Set “Make Recording Compatible” to “ON” to convert the disc.	<ul style="list-style-type: none"> • You are trying to record onto the disc that had been recorded by other recorders. 	<ul style="list-style-type: none"> • Set “Make Recording Compatible” to “ON” to rewrite the menu, after that you will record to disc (page 25).

* If you are still having trouble with the unit after checking “TROUBLESHOOTING”, write down the error code and the error description for calling our help line mentioned on the front page to locate an Authorized Service Center.

LANGUAGE CODE

Language	Code
Abkhazian	4748
Afar	4747
Afrikaans	4752
Albanian	6563
Amharic	4759
Arabic	4764
Armenian	5471
Assamese	4765
Aymara	4771
Azerbaijani	4772
Bashkir	4847
Basque	5167
Bengali; Bangla	4860
Bhutani	5072
Bihari	4854
Bislama	4855
Breton	4864
Bulgarian	4853
Burmese	5971
Byelorussian	4851
Cambodian	5759
Catalan	4947
Chinese	7254
Corsican	4961
Croatian	5464
Czech	4965
Danish	5047
Dutch	6058
English	5160
Esperanto	5161
Estonian	5166
Faroese	5261
Fiji	5256
Finnish	5255
French	5264
Frisian	5271
Galician	5358
Georgian	5747
German	5051
Greek	5158
Greenlandic	5758
Guarani	5360
Gujarati	5367
Hausa	5447
Hebrew	5569
Hindi	5455

Language	Code
Hungarian	5467
Icelandic	5565
Indonesian	5560
Interlingua	5547
Interlingue	5551
Inupiak	5557
Irish	5347
Italian	5566
Japanese	5647
Javanese	5669
Kannada	5760
Kashmiri	5765
Kazakh	5757
Kinyarwanda	6469
Kirghiz	5771
Kirundi	6460
Korean	5761
Kurdish	5767
Laothian	5861
Latin	5847
Latvian; Lettish	5868
Lingala	5860
Lithuanian	5866
Macedonian	5957
Malagasy	5953
Malay	5965
Malayalam	5958
Maltese	5966
Maori	5955
Marathi	5964
Moldavian	5961
Mongolian	5960
Nauru	6047
Nepali	6051
Norwegian	6061
Occitan	6149
Oriya	6164
Oromo (Afan)	6159
Panjabi	6247
Pashto; Pushto	6265
Persian	5247
Polish	6258
Portuguese	6266
Quechua	6367
Rhaeto-Romance	6459
Romanian	6461

Language	Code
Russian	6467
Samoan	6559
Sangho	6553
Sanskrit	6547
Scots Gaelic	5350
Serbian	6564
Serbo-Croatian	6554
Sesotho	6566
Setswana	6660
Shona	6560
Sindhi	6550
Singhalese	6555
Siswat	6565
Slovak	6557
Slovenian	6558
Somali	6561
Spanish	5165
Sundanese	6567
Swahili	6569
Swedish	6568
Tagalog	6658
Tajik	6653
Tamil	6647
Tatar	6666
Telugu	6651
Thai	6654
Tibetan	4861
Tigrinya	6655
Tonga	6661
Tsonga	6665
Turkish	6664
Turkmen	6657
Twi	6669
Ukrainian	6757
Urdu	6764
Uzbek	6772
Vietnamese	6855
Volapuk	6861
Welsh	4971
Wolof	6961
Xhosa	7054
Yiddish	5655
Yoruba	7161
Zulu	7267

Introduction

Connections

Basic Setup

Recording

Playback

Editing

Function Setup

VCR Functions

Others

Español

GLOSSARY

Analog Audio

An electrical signal that directly represents sound. Compare this to digital audio which can be an electrical signal, but is an indirect representation of sound. See also "Digital Audio".

Aspect Ratio

The width of a TV screen relative to its height. Conventional TVs are 4:3 (in other words, the TV screen is almost square); widescreen models are 16:9 (the TV screen is almost twice as wide as it is high).

Chapter

Just as a book is split up into several chapters, a title on a DVD is usually divided into chapters. See also "Title".

Component Video Output

Each signal of luminance (Y) and component (P_B/C_B, P_R/C_R) is independent to output so that you can experience picture color as it is. Also, due to compatibility with progressive video (525p/480p), you can experience higher-density picture than that in interlace (525i/480i).

Digital Audio

An indirect representation of sound by numbers. During recording, the sound is measured at discrete intervals (44,100 times a second for CD audio) by an analog-to-digital converter, generating a stream of numbers. On playback, a digital-to-analog converter generates an analog signal based on these numbers. See also "Sampling Frequency" and "Analog Audio".

Dolby Digital

The system to compress digital sound developed by Dolby Laboratories. It offers you sound of stereo(2ch) or multi channel audio.

Finalize

To make DVD, which have been recorded on, possible to play back in DVD players. With this unit, it is possible to finalize DVD+R, DVD-RW, and DVD-R.

HDMI™ (high definition multimedia interface)

A digital interface between audio and video source. It can transmit component video, audio, and control signal with one cable connection.

MP3 (MPEG audio layer 3)

MP3 is a method of compressing files. You can copy MP3 files on CD-RW/-R from the computer and play back the files on this unit.

PBC (playback control) (video CD only)

This function enables you to play back interactive software using a menu screen. See also "Video CD".

PCM (pulse code modulation)

The most common system of encoding digital audio, found on CD and DAT. Excellent quality, but requires a lot of data compared to formats such as Dolby Digital and MPEG audio. For compatibility with digital audio recorders (CD, MD and DAT) and AV amplifiers with digital inputs, this unit can convert Dolby Digital and MPEG audio to PCM. See also "Digital Audio".

Progressive Scan (525p/480p)

A type of display that does not split each frame into fields, and instead scans directly through all the scanlines of each frame in order. Progressive scan provides less flickering and higher image resolution than traditional (525i/480i) TV signals. Refer to page 76 for instructions on selective progressive scan mode.

Region Code

Regions associate discs and players with particular areas of the world. This unit will only play back discs that have compatible region codes. You can find the region code of your unit by looking on the rear panel. Some discs are compatible with more than one region (or all regions).

Sampling Frequency

The rate which sound is measured by a specified interval to turn into digital audio data. The numbers of sampling in one second defines as sampling frequency. The higher the rate, the better the sound quality.

S-Video Output

It delivers independently each signal of color(C) and luminance(Y) to TV as video signals, so that higher-quality picture will be gained.

Title (DVD only)

A collection of chapters on DVD. See also "Chapter".

Track

Audio CD use tracks to divide up the content of a disc. The DVD equivalent is called a chapter. See also "Chapter".

Video CD

A digital format for store video data in compact disc.

SPECIFICATIONS

General

VCR video heads	Four heads
Power requirements	120V AC +/-10%, 60Hz +/-5%
Power consumption	30W (standby: 3.3W)
Dimensions (width x height x depth)	17.2 x 4.0 x 10.3 inches (435 x 99.5 x 260mm)
Weight	9.5 lbs. (4.3kg)
Operating temperature	41°F (5°C) to 104°F (40°C)
Operating humidity	Less than 80% (no condensation)

Recording

Recording format	+VR (video recording) format
Recording discs	DVD+Rewritable, DVD+Recordable DVD-Rewritable, DVD-Recordable (+VR mode only)

Video recording format

Sampling frequency	13.5 MHz
Compression format	MPEG

Audio recording format

Sampling frequency	48 kHz
Compression format	Dolby Digital

Terminals

	Audio input	Video input	S-video input	Audio output	Video output	S-video output	Component video output	Coaxial digital audio output	HDMI output
Front	RCA jack x 2	RCA jack x 1	Mini DIN 4-pin x 1	RCA jack x 2	RCA jack x 1	Mini DIN 4-pin x 1	RCA jack x 3	RCA jack x 1	Jack
	2V rms (input impedance: more than 22kΩ)		Y: 1Vp-p (75Ω) C: 286mVp-p (75Ω)		1Vp-p (75Ω)		Y: 1Vp-p (75Ω) Pb/Cb: 700mVp-p (75Ω) Pr/CR: 700mVp-p (75Ω)		HDMI jack
	1Vp-p (75Ω)		Y: 1Vp-p (75Ω) C: 286mVp-p (75Ω)		1Vp-p (75Ω)		500mVp-p (75Ω)		
Rear	RCA jack x 2	RCA jack x 1	Mini DIN 4-pin x 1	RCA jack x 4	RCA jack x 1	Mini DIN 4-pin x 1	RCA jack x 3	RCA jack x 1	Jack
	2V rms (input impedance: more than 22kΩ)		Y: 1Vp-p (75Ω) C: 286mVp-p (75Ω)		1Vp-p (75Ω)		Y: 1Vp-p (75Ω) Pb/Cb: 700mVp-p (75Ω) Pr/CR: 700mVp-p (75Ω)		HDMI jack
	2V rms (output impedance: more than 1kΩ)		Y: 1Vp-p (75Ω) C: 286mVp-p (75Ω)		1Vp-p (75Ω)		500mVp-p (75Ω)		
	1Vp-p (75Ω)		Y: 1Vp-p (75Ω) C: 286mVp-p (75Ω)		1Vp-p (75Ω)		500mVp-p (75Ω)		
	1Vp-p (75Ω)		Y: 1Vp-p (75Ω) C: 286mVp-p (75Ω)		1Vp-p (75Ω)		500mVp-p (75Ω)		
	1Vp-p (75Ω)		Y: 1Vp-p (75Ω) C: 286mVp-p (75Ω)		1Vp-p (75Ω)		500mVp-p (75Ω)		
	1Vp-p (75Ω)		Y: 1Vp-p (75Ω) C: 286mVp-p (75Ω)		1Vp-p (75Ω)		500mVp-p (75Ω)		

Note

- The specifications and design of this product are subject to change without notice.

Introduction

Connections

Basic Setup

Recording

Playback

Editing

Function Setup

VCR Functions

Others

Español

Discos Reproducibles

Este aparato es compatible con la reproducción de los siguientes discos y archivos.

Discos reproducibles	Logotipos
DVD-video	
DVD+RW	
DVD+R	
DVD-RW (Sólo discos en modo de video finalizados)	
DVD-R (Sólo discos en modo de video finalizados)	
CD-DA (CD de audio)	
CD de video	 
CD-RW	 
CD-R	 
Archivos reproducibles	Medio
CD-DA	CD-RW/-R
MP3	

 es una marca registrada de DVD Format/Logo Licensing Corporation.

Códigos de Región

El número presente en el interior del globo se refiere a una región del mundo. Este aparato puede reproducir discos DVD que estén rotulados para ALL las regiones o para la región 1.



Disco Grabable

Este aparato puede grabar a DVD+RW, DVD+R, DVD-RW y DVD-R.

Los discos DVD+R/DVD-R pueden ser grabados sólo una vez. Los discos DVD+RW/DVD-RW pueden ser grabados y borrados muchas veces.





En este aparato los discos DVD-RW/-R serán grabados automáticamente en el modo DVD+VR.

- Los siguientes discos se recomiendan para obtener una buena calidad de grabación y han sido comprobados como compatibles con este aparato. Sin embargo, según sea la condición del medio el equipo podría no leer el disco correctamente.

Verbatim	DVD+R 8x, DVD-R 8x,	DVD+RW 4x, DVD-RW 2x
JVC	DVD-RW 4x	
Maxell	DVD+R 4x/8x/16x,	DVD-R 8x/16x
SONY	DVD+R 4x/8x/16x,	DVD+RW 4x
TDK	DVD+R 4x/8x/16x	

El comportamiento de cualquier otro disco no está garantizado.

- **Usted puede reproducir discos DVD+RW en la mayoría de los reproductores de DVD sin finalizarlos. Sin embargo, si usted ha añadido o eliminado capítulos, u ocultado capítulos, debe ejecutar "Compatibilizar edic." antes de poder ver dichos efectos en otros equipos. (Consulte la página 69.) Para reproducir discos que no sean DVD+RW en otros reproductores de DVD, usted necesitará finalizarlos.**

Logotipo	Atributos
 	Disco de 8 cm / 12 cm, un solo lado, una sola capa Tiempo de grabación máx. aprox. (modo SLP): 360 minutos (4,7 GB) (para 12 cm) 108 minutos (1,4 GB) (para 8 cm)
DVD+RW DVD+R	
 	
DVD-RW DVD-R	

Disco no Grabable

- Un DVD-RW grabado en un modo distinto de +VR no será grabable en este aparato a menos que usted borre todo el contenido del disco. (Consulte la página 68.)
- Un DVD-R grabado en un modo distinto de +VR no será grabable en este aparato.

Conexión a un Sintonizador Externo

- 1) Desconecte el cable de alimentación de su televisor del tomacorriente de CA.
- 2) Efectúe la conexión como se ilustra abajo.

ej.)

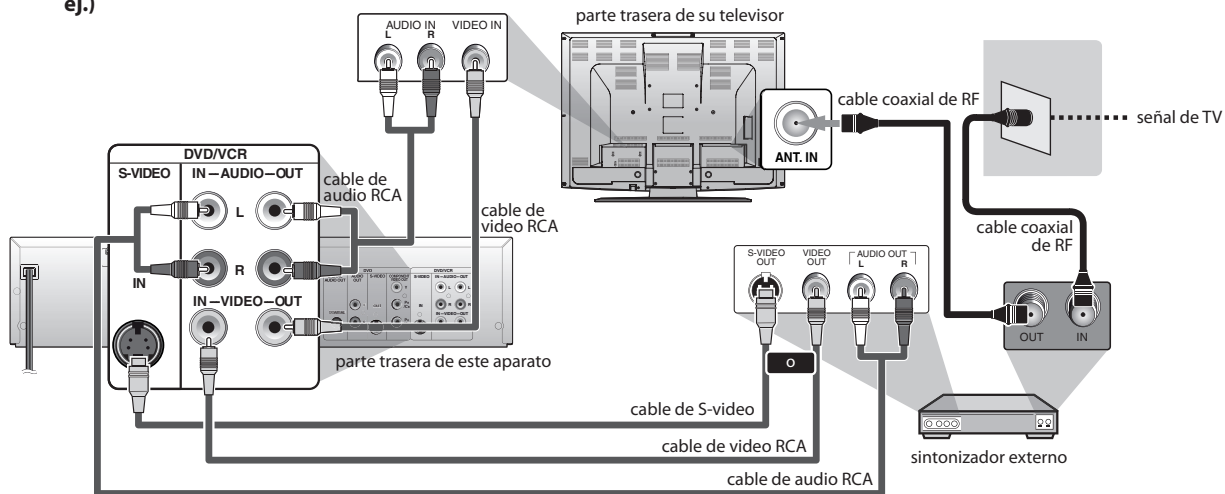

- 3) Enchufe los cables de alimentación de los aparatos al tomacorriente de CA.

Selección de un Canal de Entrada Externo en el Televisor

Luego de completar las conexiones, cambie el selector de entrada del televisor a un canal de entrada externo adecuado. Presione un botón que seleccione un canal externo de entrada en el control remoto original del televisor hasta que aparezca la imagen inicial del grabador de DVD. Para obtener detalles consulte el manual del propietario de su televisor.

Configuración de la Entrada de Video

Antes de efectuar una grabación se debe informar al aparato qué conector hembra de entrada de video se está utilizando.

1 Presione [SETUP] y utilice [▲ / ▼] para seleccionar "Ajuste general", y luego presione [OK].

2 Utilice [▲ / ▼] para seleccionar "Video", y luego presione [OK].

3 Utilice [▲ / ▼] para seleccionar "Entrada de video", y luego presione [OK].

4 Utilice [▲ / ▼] para seleccionar la posición de la entrada externa deseada, y luego presione [OK].

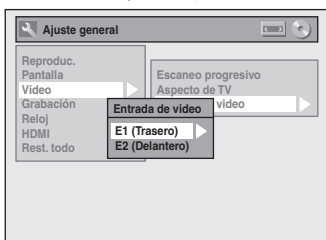

5 Utilice [▲ / ▼] para seleccionar el tipo de conector hembra de entrada a conectar, y luego presione [OK].

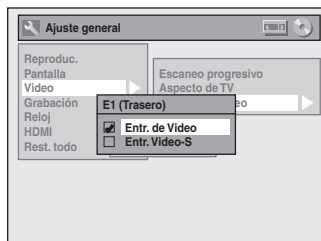



6 Para salir presione [SETUP].

Configuración Inicial

Cuando usted encienda este aparato por primera vez necesita seguir estos pasos.

1 Presione [STANDBY-ON ].



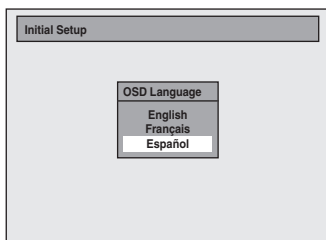

Encienda el televisor. Seleccione la entrada a la cual está conectado el aparato.

2 Utilice [ / ] para seleccionar su idioma deseado, y luego presione [OK] para establecerlo.

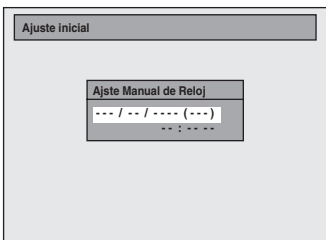

3 Presione [OK] para activar "Ajuste Manual de Reloj".



4 Utilice [ / ] para seleccionar un elemento a configurar, y utilice [ / ] para seleccionar el contenido de su preferencia, y luego presione [OK].

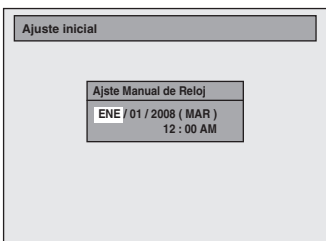

Grabación Básica

1 Presione [DVD]. Presione [OPEN/CLOSE ] para abrir la bandeja de discos e insertar su disco con el rótulo apuntando hacia arriba.

* Asegúrese de que el disco sea compatible con este aparato. (Para obtener la lista de discos compatibles consulte la página 24.)

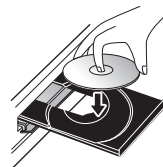

2 Para seleccionar un modo de grabación presione [REC MODE].

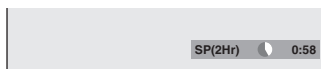

Modo de grabación	Tiempo de grabación		Calidad del video y el sonido
	Disco de 8 cm	Disco de 12 cm	
HQ (1Hr)	18 min	60 min	Buena ↑ ↓ Deficiente
SP (2Hr)	36 min	120 min	
SPP (2.5Hr)	45 min	150 min	
LP (3Hr)	54 min	180 min	
EP (4Hr)	72 min	240 min	
SLP (6Hr)	108 min	360 min	

3 Presione [SOURCE] para seleccionar la posición adecuada de la entrada externa (E1/E2) a la cual está conectado su sintonizador externo. Luego seleccione en el sintonizador externo el canal que desea grabar.

4 Presione [REC ] para iniciar la grabación.

Para configurar la grabación a un toque con temporizador (OTR)...

Esta es una manera sencilla de configurar el tiempo de grabación en bloques de 30 minutos.

Presione [REC ] repetidamente hasta que aparezca en la pantalla del televisor la longitud deseada de grabación (30 minutos a 6 horas).

Comenzará la grabación a un toque con temporizador.

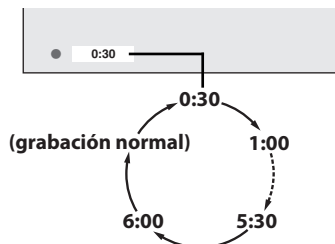

• Para cancelar la grabación a un toque con temporizador dentro del tiempo especificado, presione [STOP ].

5 Para de tener la grabación presione [STOP ].

Grabación con Temporizador

Usted puede programar el equipo para que grabe hasta 12 programas, con un mes de anticipación. También hay disponibles grabaciones de programas diarias o semanales.

Antes de grabar, asegúrese de que

- Cuando llegue el momento en que desea empezar a grabar, conecte el sintonizador externo a ya sea E1 o E2 y configúrelo para dar salida a las señales de audio/video.
- No cambie el canal del sintonizador externo cuando esté grabando. Usted no puede mirar un canal y grabar otro al mismo tiempo.
- Antes de establecer una programación del temporizador configure el reloj.
- Inserte un disco grabable con suficiente espacio libre.

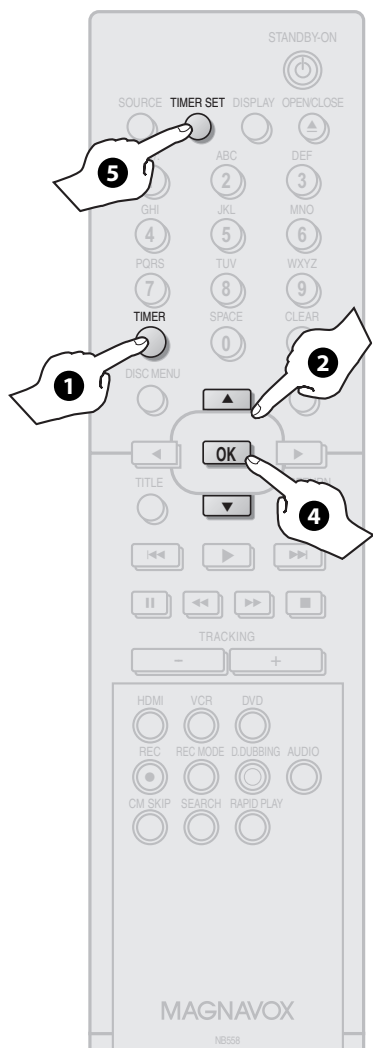

1 Presione [TIMER].

2 Utilice [▲ / ▼] para seleccionar "Prog. nuevo", y luego presione [OK].



3 Configure una programación del temporizador.

4 Presione [OK].

5 Presione [TIMER SET] para configurar una programación del temporizador. Aparecerá en el pantalla del panel frontal.

Configure la fecha.



Configure las horas de inicio y finalización.



Seleccione la posición adecuada de la entrada externa (E1/E2) a la cual está conectado su sintonizador externo.



Seleccione un medio de grabación ("DVD" o "VCR").

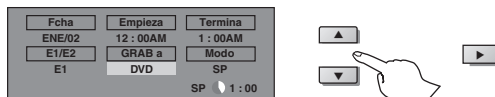

Seleccione un modo de grabación.



Reproducción

1 Abra la bandeja de discos.

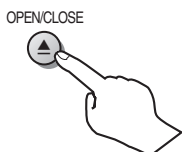

2 Inserte un disco.

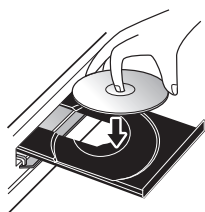

3 Comience a reproducir.

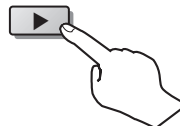

4 Detenga la reproducción.

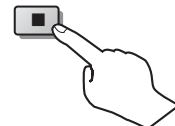

MAGNAVOX

LIMITED WARRANTY

FUNAI CORP. will repair this product, free of charge in the USA in the event of defect in materials or workmanship as follows:

DURATION:

PARTS: FUNAI CORP. will provide parts to replace defective parts without charge for one (1) year from the date of original retail purchase. Certain parts are excluded from this warranty.

LABOR: FUNAI CORP. will provide the labor without charge for a period of ninety (90) days from the date of original retail purchase.

LIMITS AND EXCLUSIONS:

THIS WARRANTY IS EXTENDED ONLY TO THE ORIGINAL RETAIL PURCHASER. A PURCHASE RECEIPT OR OTHER PROOF OF ORIGINAL RETAIL PURCHASE WILL BE REQUIRED TOGETHER WITH THE PRODUCT TO OBTAIN SERVICE UNDER THIS WARRANTY.

This warranty shall not be extended to any other person or transferee.

This warranty is void and of no effect if any serial numbers on the product are altered, replaced, defaced, missing or if service was attempted by an unauthorized service center. This limited warranty does not apply to any product not purchased and used in the United States.

This warranty only covers failures due to defects in material or workmanship which occur during normal use. It does not cover damage which occurs in shipment, or failures which are caused by repairs, alterations or products not supplied by FUNAI CORP., or damage, which results from accident, misuse, abuse, mishandling, misapplication, alteration, faulty installation, improper maintenance, commercial use such as hotel, rental or office use of this product, or damage which results from fire, flood, lightning or other acts of God.

THIS WARRANTY DOES NOT COVER PACKING MATERIALS, ANY ACCESSORIES (EXCEPT REMOTE CONTROL), ANY COSMETIC PARTS, COMPLETE ASSEMBLY PARTS, DEMO OR FLOOR MODELS.

FUNAI CORP. AND ITS REPRESENTATIVES OR AGENTS SHALL IN NO EVENT BE LIABLE FOR ANY GENERAL, INDIRECT OR CONSEQUENTIAL DAMAGES ARISING OUT OF OR OCCASIONED BY THE USE OF OR THE INABILITY TO USE THIS PRODUCT. THIS WARRANTY IS MADE IN LIEU OF ALL OTHER WARRANTIES, EXPRESS OR IMPLIED, AND OF ALL OTHER LIABILITIES ON THE PART OF FUNAI, ALL OTHER WARRANTIES INCLUDING THE WARRANTY OF MERCHANTABILITY AND FITNESS FOR A PARTICULAR PURPOSE, ARE HEREBY DISCLAIMED BY FUNAI AND ITS REPRESENTATIVES IN THE UNITED STATES.

ALL WARRANTY INSPECTIONS AND REPAIRS MUST BE PERFORMED BY AN AUTHORIZED SERVICE CENTER.

THIS WARRANTY IS ONLY VALID WHEN THE UNIT IS CARRIED-IN TO AN AUTHORIZED SERVICE CENTER.

THE PRODUCT MUST BE ACCOMPANIED BY A COPY OF THE ORIGINAL RETAIL PURCHASE RECEIPT. IF NO PROOF OF PURCHASE IS ATTACHED, THE WARRANTY WILL NOT BE HONORED AND REPAIR COSTS WILL BE CHARGED.

IMPORTANT:

THIS LIMITED WARRANTY GIVES YOU SPECIFIC LEGAL RIGHTS. YOU MAY HAVE OTHER RIGHTS THAT VARY FROM STATE TO STATE. IF, AT ANY TIME DURING THE WARRANTY PERIOD, YOU ARE UNABLE TO OBTAIN SATISFACTION WITH THE REPAIR OF THIS PRODUCT, PLEASE CONTACT FUNAI CORP.

ATTENTION:

FUNAI CORP. RESERVES THE RIGHT TO MODIFY ANY DESIGN OF THIS PRODUCT WITHOUT PRIOR NOTICE.

WARRANTY STATEMENT REGARDING NON AUTHORIZED REPAIRS:

To obtain warranty service, you must take the product, or deliver the product freight prepaid, in either its original packaging or packaging affording an equal degree of protection, to any AUTHORIZED SERVICE CENTER. FUNAI CORP. will not reimburse you for any service done by unauthorized service providers without prior written approval.

To locate your nearest AUTHORIZED SERVICE CENTER or for general service inquiries, please contact us at:

FUNAI CORPORATION

Customer Service

Tel: 1-800-605-8610

<http://www.funai-corp.com>

19900 Van Ness Avenue, Torrance, CA 90501